



SGS-CSTC Standards Technical Services (Shanghai) Co., Ltd.

588 West Jindu Road, Xinqiao, Songjiang, 201612 Shanghai, China
Telephone: +86 (0) 21 6191 5666
Fax: +86 (0) 21 6191 5678
ee.shanghai@sgs.com

Report No.: SHEM181000877601
Page: 1 of 71

TEST REPORT

Application No.: SHEM1810008776TX
Applicant: Ningbo Airtac Industrial Co., Ltd.
Address of Applicant: No. 88, Siming E.R.D., High Tech Area of Fenghua City, Zhejiang, China
Manufacturer: Ningbo Airtac Industrial Co., Ltd.
Address of Manufacturer: No. 88, Siming E.R.D., High Tech Area of Fenghua City, Zhejiang, China
Factory: Ningbo Airtac Industrial Co., Ltd.
Address of Factory: No. 88, Siming E.R.D., High Tech Area of Fenghua City, Zhejiang, China
Equipment Under Test (EUT):
EUT Name: Coil
Model No.: CDB092A, CDB092E, CDB092B, CDB092F, CDB092C
Standard(s) : EN 61000-6-3:2007 +A1:2011
 EN 61000-6-1:2007
Date of Receipt: 2018-10-10
Date of Test: 2018-10-11 to 2018-10-19
Date of Issue: 2018-11-30

Test Result:	Pass*
---------------------	--------------

* In the configuration tested, the EUT complied with the standards specified above.

The CE mark as shown below can be used, under the responsibility of the manufacturer, after completion of an EU Declaration of Conformity and compliance with all relevant EU Directives.



Parlam Zhan
E&E Section Manager

The manufacturer should ensure that all products in series production are in conformity with the product sample detailed in this report. If the product in this report is used in any configuration other than that detailed in the report, the manufacturer must ensure the new system complies with all relevant standards. Any mention of SGS International Electrical Approvals or testing done by SGS International Electrical Approvals in connection with, distribution or use of the product described in this report must be approved by SGS International Electrical Approvals in writing.

This document is issued by the Company subject to its General Conditions of Service printed overleaf, available on request or accessible at <http://www.sgs.com/en/Terms-and-Conditions.aspx> and, for electronic format documents, subject to Terms and Conditions for Electronic Documents at <http://www.sgs.com/en/Terms-and-Conditions/Terms-e-Document.aspx>. Attention is drawn to the limitation of liability, indemnification and jurisdiction issues defined therein. Any holder of this document is advised that information contained hereon reflects the Company's findings at the time of its intervention only and within the limits of Client's instructions, if any. The Company's sole responsibility is to its Client and this document does not exonerate parties to a transaction from exercising all their rights and obligations under the transaction documents. This document cannot be reproduced except in full, without prior written approval of the Company. Any unauthorized alteration, forgery or falsification of the content or appearance of this document is unlawful and offenders may be prosecuted to the fullest extent of the law. Unless otherwise stated the results shown in this test report refer only to the sample(s) tested and such sample(s) are retained for 30 days only.



Revision Record			
Version	Description	Date	Remark
00	Original	2018-11-30	/

Authorized for issue by:			
			
	<hr/>		
	Leo Xu / Project Engineer		
			
	<hr/>		
	Bruce Tang / Reviewer		

2 Test Summary

Emission Part				
Item	Standard	Method	Requirement	Result
Conducted Emissions at Mains Terminals (150kHz-30MHz)	EN 61000-6-3:2007 +A1:2011	CISPR 16-2-1	N/A	Pass
Radiated Emissions (30MHz-1GHz)	EN 61000-6-3:2007 +A1:2011	CISPR 16-2-3	N/A	Pass
Harmonic Current Emission	EN 61000-6-3:2007 +A1:2011	EN 61000-3-2:2014	Class A	N/A
Voltage Fluctuations and Flicker	EN 61000-6-3:2007 +A1:2011	EN 61000-3-3:2013	Clause 5 of EN 61000-3-3	Pass

N/A: Not applicable

N/A*: Please refer to Section 6.3 of this report for details.

Immunity Part				
Item	Standard	Method	Requirement	Result
Electrostatic Discharge	EN 61000-6-1:2007	EN 61000-4-2:2009	4kV Contact Discharge 8kV Air Discharge	Pass
Electrical Fast Transients/Burst at Power Port	EN 61000-6-1:2007	EN 61000-4-4:2012	1kV 5/50ns Tr/Td 5kHz Repetition Frequency	Pass
Surge at Power Port	EN 61000-6-1:2007	EN 61000-4-5:2014 +A1:2017	1.2/50µs Tr/Td 0.5kV Line to Line 0.5kV Line to Ground	Pass
Conducted Immunity at Power Port (150kHz-80MHz)	EN 61000-6-1:2007	EN 61000-4-6:2014	3Vrms (emf), 80%, 1kHz Amp. Mod.	Pass
Power Frequency Magnetic Field	EN 61000-6-1:2007	EN 61000-4-8:2010	50Hz 3A/m	Pass
Voltage Dips and Interruptions	EN 61000-6-1:2007	EN 61000-4-11:2004 +A1:2017	0 % UT for 0.5per 0 % UT for 1per 70 % UT for 25per 0 % UT for 250per UT is Supply Voltage	Pass
Radiated Immunity(80MHz-2.7GHz)	EN 61000-6-1:2007	EN 61000-4-3:2006 +A1:2008+A2:2010	3V/m, 80%, 1kHz Amp. Mod. 3V/m, 80%, 1kHz Amp. Mod. 1V/m, 80%, 1kHz Amp. Mod.	Pass

N/A: Not applicable



3 Contents

	Page
1 COVER PAGE.....	1
2 TEST SUMMARY	3
3 CONTENTS.....	4
4 GENERAL INFORMATION.....	5
4.1 DETAILS OF E.U.T.	5
4.2 DESCRIPTION OF SUPPORT UNITS	5
4.3 MEASUREMENT UNCERTAINTY.....	5
4.4 TEST LOCATION.....	6
4.5 TEST FACILITY.....	6
4.6 DEVIATION FROM STANDARDS.....	6
4.7 ABNORMALITIES FROM STANDARD CONDITIONS.....	6
4.8 MONITORING OF EUT FOR ALL IMMUNITY TEST	6
5 EQUIPMENT LIST	7
6 EMISSION TEST RESULTS	10
6.1 CONDUCTED EMISSIONS AT MAINS TERMINALS (150KHZ-30MHZ)	10
6.2 RADIATED EMISSIONS (30MHZ-1GHZ)	21
6.3 HARMONIC CURRENT EMISSION	32
6.4 VOLTAGE FLUCTUATIONS AND FLICKER	33
7 IMMUNITY TEST RESULTS.....	35
7.1 PERFORMANCE CRITERIA DESCRIPTION IN EN 61000-6-1:2007	35
7.2 ELECTROSTATIC DISCHARGE	36
7.3 ELECTRICAL FAST TRANSIENTS/BURST AT POWER PORT	37
7.4 SURGE AT POWER PORT	38
7.5 CONDUCTED IMMUNITY AT POWER PORT (150KHZ-80MHZ).....	40
7.6 POWER FREQUENCY MAGNETIC FIELD	41
7.7 VOLTAGE DIPS AND INTERRUPTIONS	42
7.8 RADIATED IMMUNITY(80MHZ-2.7GHZ)	43
8 PHOTOGRAPHS.....	45
8.1 CONDUCTED EMISSIONS AT MAINS TERMINALS (150KHZ-30MHZ) TEST SETUP	45
8.2 RADIATED EMISSIONS (30MHZ-1GHZ) TEST SETUP.....	47
8.3 VOLTAGE FLUCTUATIONS AND FLICKER TEST SETUP	49
8.4 ELECTROSTATIC DISCHARGE TEST SETUP.....	52
8.5 ELECTRICAL FAST TRANSIENTS/BURST AT POWER PORT TEST SETUP	55
8.6 SURGE AT POWER PORT TEST SETUP.....	56
8.7 CONDUCTED IMMUNITY AT POWER PORT (150KHZ-80MHZ) TEST SETUP.....	58
8.8 POWER FREQUENCY MAGNETIC FIELD TEST SETUP	61
8.9 VOLTAGE DIPS AND INTERRUPTIONS TEST SETUP	62
8.10 RADIATED IMMUNITY(80MHZ-2.7GHZ) TEST SETUP.....	64
8.11 EUT CONSTRUCTIONAL DETAILS (EUT PHOTOS).....	67-71

4 General Information

4.1 Details of E.U.T.

Power supply: CDB092A: AC220V,
 CDB092E: AC24V,
 CDB092B: DC24V,
 CDB092F: DC12V,
 CDB092C: AC110V

4.2 Description of Support Units

Description	Manufacturer	Model No.	Serial No.
DC power supply	MCH	MCH-303A	

4.3 Measurement Uncertainty

No.	Item	Measurement Uncertainty
1	Conducted Emission at mains port using AMN	±3.2dB (9kHz to 150kHz)
		±3.0dB (150kHz to 30MHz)
2	Conducted Emission at mains port using VP	±1.9 dB (9kHz to 30MHz)
3	Conducted Emission at telecommunication port using AAN	±2.4 dB (150kHz to 30MHz)
4	Radiated Power	±3.5dB
5	Radiated emission	±4.4dB (30MHz-1GHz)
		±4.6dB (1GHz-6GHz)

Note: The measurement uncertainty represents an expanded uncertainty expressed at approximately the 95% confidence level using a coverage factor of k=2.

4.4 Test Location

All tests were performed at:

SGS-CSTC Standards Technical Services (Shanghai) Co., Ltd. E&E Lab
588 West Jindu Road, Xinqiao, Songjiang, 201612 Shanghai, China
Tel: +86 21 6191 5666 Fax: +86 21 6191 5678

No tests were sub-contracted.

4.5 Test Facility

The test facility is recognized, certified, or accredited by the following organizations:

- **CNAS (No. CNAS L0599)**

CNAS has accredited SGS-CSTC Standards Technical Services (Shanghai) Co., Ltd. to ISO/IEC 17025:2005 General Requirements for the Competence of Testing and Calibration Laboratories (CNAS-CL01 Accreditation Criteria for the Competence of Testing and Calibration Laboratories) for the competence in the field of testing.

- **NVLAP (Certificate No. 201034-0)**

SGS-CSTC Standards Technical Services (Shanghai) Co., Ltd. is accredited by the National Voluntary Laboratory Accreditation Program (NVLAP). Certificate No. 201034-0.

- **FCC –Designation Number: CN5033**

SGS-CSTC Standards Technical Services (Shanghai) Co., Ltd. has been recognized as an accredited testing laboratory.

Designation Number: CN5033. Test Firm Registration Number: 479755.

- **Industry Canada (IC) – IC Assigned Code: 8617A**

The 3m Semi-anechoic chamber of SGS-CSTC Standards Technical Services (Shanghai) Co., Ltd. has been registered by Certification and Engineering Bureau of Industry Canada for radio equipment testing with Registration No.: 8617A-1.

- **VCCI (Member No.: 3061)**

The 3m Semi-anechoic chamber and Shielded Room of SGS-CSTC Standards Technical Services (Shanghai) Co., Ltd. has been registered in accordance with the Regulations for Voluntary Control Measures with Registration No.: R-13868, C-14336, T-12221, G-10830 respectively.

4.6 Deviation from Standards

None

4.7 Abnormalities from Standard Conditions

None

4.8 Monitoring of EUT for All Immunity Test

Visual: working status

5 Equipment List

Conducted Emissions at Mains Terminals (150kHz-30MHz)					
Equipment	Manufacturer	Model No	Inventory No	Cal Date	Cal Due Date
EMI test receiver	Rohde & Schwarz	ESR7	SHEM162-1	2017-12-20	2018-12-19
Line impedance stabilization network	SCHWARZBECK	NSLK8127	SHEM061-1	2017-12-20	2018-12-19
Line impedance stabilization network	EMCO	3816/2	SHEM019-1	2017-12-20	2018-12-19
Pulse limiter	Rohde & Schwarz	ESH3-Z2	SHEM029-1	2017-12-20	2018-12-19
Shielding Room	ZHONGYU	8*4*3M	SHEM079-2	2017-12-20	2020-12-19
CE test Cable	/	/	CE01	2017-12-26	2018-12-25

Radiated Emissions (30MHz-1GHz)					
Equipment	Manufacturer	Model No	Inventory No	Cal Date	Cal Due Date
EMI test receiver	Rohde & Schwarz	ESU40	SHEM051-1	2017-12-20	2018-12-19
CONTROLLER	INNCO	CO200	SHEM047-1	N/A	N/A
ANTENNA MAST	INNCO	MA400-EP	SHEM047-2	N/A	N/A
TURN DEVICE	INNCO	DE 3600-RH	SHEM047-3	N/A	N/A
Broadband UHF-VHF ANTENNA	SCHWARZBECK	VULB9168	SHEM048-1	2017-02-28	2020-02-27
Semi/Fully Anechoic	ST	11*6*6M	SHEM078-2	2017-07-22	2020-07-21
Low Amplifier	CLAVIIO	BDLNA-0001-412010	SHEM164-1	2018-08-13	2019-08-12

Voltage Fluctuations and Flicker					
Equipment	Manufacturer	Model No	Inventory No	Cal Date	Cal Due Date
Harmonic&Flicker analyzer	AMETEK	PACS-1	SHEM024-2	2018-08-13	2019-08-12
AC Power Source 5KVA	AMETEK	5001iX	SHEM025-2	2018-08-13	2019-08-12

Electrostatic Discharge					
Equipment	Manufacturer	Model No	Inventory No	Cal Date	Cal Due Date
Electrostatic Discharge Simulator	TESEQ	NSG 437	SHEM041-2	2018-08-13	2019-08-12

Electrical Fast Transients/Burst at Power Port					
Equipment	Manufacturer	Model No	Inventory No	Cal Date	Cal Due Date
Immunity Test System	EMC PARTNER	TRA3000 F-S-D-V	SHEM163-1	2017-12-20	2018-12-19

Surge at Power Port					
Equipment	Manufacturer	Model No	Inventory No	Cal Date	Cal Due Date
Immunity Test System	EMC PARTNER	TRA3000 F-S-D-V	SHEM163-1	2017-12-20	2018-12-19



Conducted Immunity at Power Port (150kHz-80MHz)					
Equipment	Manufacturer	Model No	Inventory No	Cal Date	Cal Due Date
Signal generator	Rohde & Schwarz	SMJ100A	SHEM141-1	2018-08-13	2019-08-12
PAMP Conducted RF test system	HAEFFLY	PAMP250	SHEM023-1	2017-12-20	2018-12-19
6dB Attenuator	HUAXIANG	DTS50-6dB-1G-A	SHEM123-2	2017-12-25	2018-12-24
Coupling clamp	LIITHI	EM 101	SHEM027-1	2017-12-20	2018-12-19
CDN impedance and K-factor	LUTHI	L-801 M1	SHEM023-5	2017-12-20	2018-12-19
CDN impedance and K-factor	LUTHI	L-801 M2/M3	SHEM023-6	2017-12-20	2018-12-19
Shielding Room	ZHONGYU	5*5*3M	SHEM079-6	2016-12-29	2019-12-28
Coupling and Decoupling Network	Teseq	CDN M016	SHEM168-1	2018-08-13	2019-08-12

Power Frequency Magnetic Field					
Equipment	Manufacturer	Model No	Inventory No	Cal Date	Cal Due Date
Immunity Test System	EMC PARTNER	TRA3000 F-S-D-V	SHEM163-1	2017-12-20	2018-12-19
Motorised Variac	MV2616	MV2616	SHEM026-6	N/A	N/A
Current transformer for magnetic field coil	EM test	MC2630	SHEM026-7	2017-12-20	2018-12-19
Current transformer for magnetic field coil	EM test	MC26100	SHEM026-8	2017-12-20	2018-12-19
Magnetic field coil	EM test	MS100	SHEM026-9	2017-12-20	2018-12-19

Voltage Dips and Interruptions					
Equipment	Manufacturer	Model No	Inventory No	Cal Date	Cal Due Date
Immunity Test System	EMC PARTNER	TRA3000 F-S-D-V	SHEM163-1	2017-12-20	2018-12-19

Radiated Immunity(80MHz-2.7GHz)					
Equipment	Manufacturer	Model No	Inventory No	Cal Date	Cal Due Date
Signal generator	Rohde & Schwarz	SMJ100A	SHEM141-1	2018-08-13	2019-08-12
Power Meter	Rohde & Schwarz	NRP	SHEM057-1	2017-12-20	2018-12-19
Power meter sensor	Rohde & Schwarz	NRP-Z91	SHEM057-2	2017-12-20	2018-12-19
Antenna	SCHWARZBECK	STLP9128D	SHEM130-1	N/A	N/A
Antenna	SCHWARZBECK	STLP9149	SHEM131-1	N/A	N/A
Amplifier	MILMEGA	80RF1000-250	SHEM132-1	N/A	N/A
Amplifier	MILMEGA	AS0840-55-55	SHEM133-1	N/A	N/A
Power meter sensor	Rohde & Schwarz	NRP-Z22	SHEM136-1	2017-12-19	2018-12-18
ElectroMagnetic Field Probe	ETS-Lindgren	HI-6113	SHEM134-1	2017-12-19	2018-12-18
Semi/Fully Anechoic	ST	11*6*6M	SHEM078-2	2017-07-22	2020-07-21



General used equipment					
Equipment	Manufacturer	Model No	Inventory No	Cal Date	Cal Due Date
Digital pressure meter	YONGZHI	DYM3-01	SHEM082-1	2018-01-25	2021-01-24
Temperature&humidity recorder	ShangHai weather meter work	ZJ 1-2B	SHEM042-1~6	2018-08-31	2019-08-30
Digital Multimeter	FLUKE	17B	SHEM043-3	2018-09-03	2019-09-02
Autoformer regulator	Guangzhou bao de	TDGC2-5KVA	SHEM150-1	N/A	N/A
Multi-purpose tong tester	FLUKE	316	SHEM001-1	2017-12-20	2018-12-19

6 Emission Test Results

6.1 Conducted Emissions at Mains Terminals (150kHz-30MHz)

Test Requirement:	EN 61000-6-3:2007 +A1:2011
Test Method:	CISPR 16-2-1
Frequency Range:	150kHz to 30MHz
Limit:	
0.15M-0.5MHz	66dB(μ V)-56dB(μ V) quasi-peak, 56dB(μ V)-46dB(μ V) average
0.5M-5MHz	56dB(μ V) quasi-peak, 46dB(μ V) average
5M-30MHz	60dB(μ V) quasi-peak, 50dB(μ V) average
Detector:	Peak for pre-scan (9kHz resolution bandwidth) 0.15M to 30MHz

6.1.1 E.U.T. Operation

Operating Environment:

Temperature: 22 °C Humidity: 50 % RH Atmospheric Pressure: 1002 mbar

Test mode:

- a: Keep mode CDB092A running with AC220V,
- b: Keep mode CDB092E running with AC24V,
- c: Keep mode CDB092B running with DC24V,
- d: Keep mode CDB092F running with DC12V,
- e: Keep mode CDB092C running with AC110V.

6.1.2 Test Setup Diagram

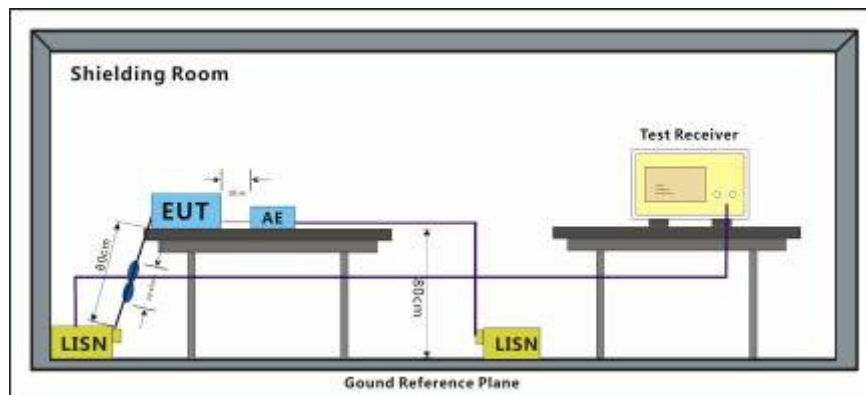

6.1.3 Measurement Data

An initial pre-scan was performed with peak detector. Quasi-Peak or Average measurement were performed at the frequencies with maximized peak emission were detected.

Mode:a; Line:Live Line

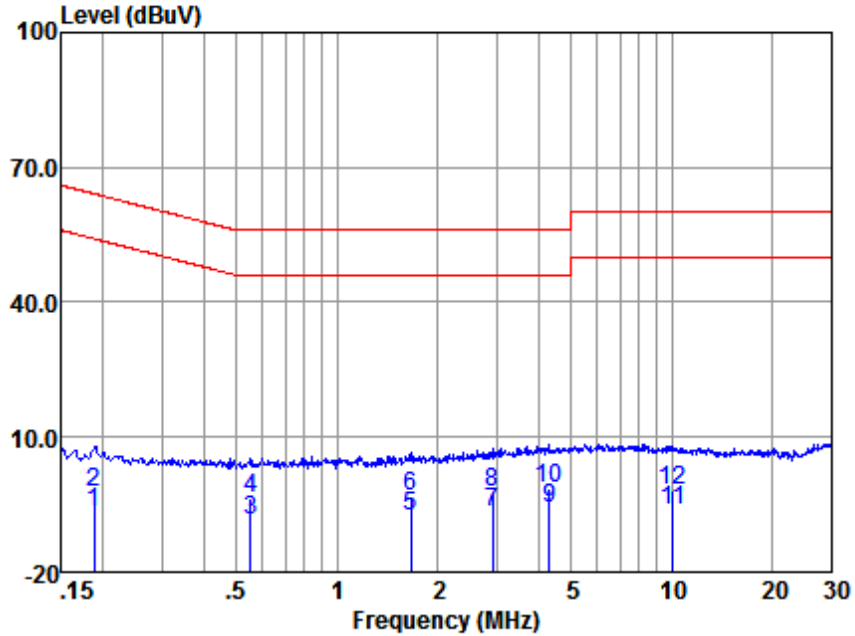

LISN : LINE
 EUT/Project No : 8776TX
 Test mode : a

	Freq (MHz)	Read level (dBuV)	LISN Factor (dB)	Cable Loss (dB)	Emission Level (dBuV)	Limit (dBuV)	Over Limit (dB)	Remark
1	0.19	-16.69	0.05	9.83	-6.81	54.11	-60.92	Average
2	0.19	-12.01	0.05	9.83	-2.13	64.11	-66.24	QP
3	0.55	-18.17	0.05	9.75	-8.37	46.00	-54.37	Average
4	0.55	-13.59	0.05	9.75	-3.79	56.00	-59.79	QP
5	1.66	-17.67	0.05	9.88	-7.74	46.00	-53.74	Average
6	1.66	-13.11	0.05	9.88	-3.18	56.00	-59.18	QP
7	2.92	-16.70	0.06	9.86	-6.78	46.00	-52.78	Average
8	2.92	-12.34	0.06	9.86	-2.42	56.00	-58.42	QP
9	4.31	-15.93	0.08	9.86	-5.99	46.00	-51.99	Average
10	4.31	-11.42	0.08	9.86	-1.48	56.00	-57.48	QP
11	10.07	-16.04	0.21	9.73	-6.10	50.00	-56.10	Average
12	10.07	-11.57	0.21	9.73	-1.63	60.00	-61.63	QP

Notes: Emission Level = Read Level + LISN Factor + Cable loss

Mode:a; Line:Neutral Line

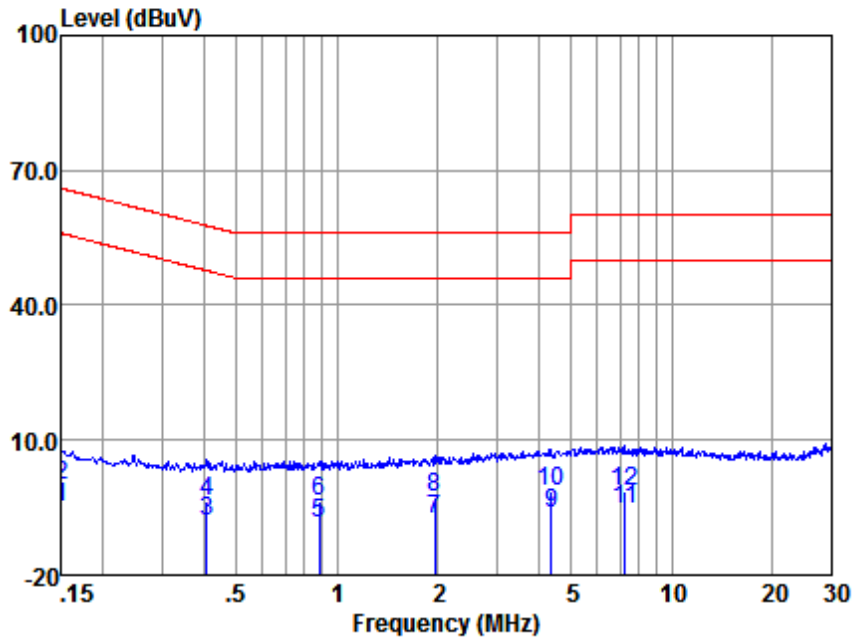

LISN : NEUTRAL
 EUT/Project No : 8776TX
 Test mode : a

	Freq (MHz)	Read level (dBuV)	LISN Factor (dB)	Cable Loss (dB)	Emission Level (dBuV)	Limit (dBuV)	Over Limit (dB)	Remark
1	0.15	-14.75	0.06	9.82	-4.87	56.00	-60.87	Average
2	0.15	-10.06	0.06	9.82	-0.18	66.00	-66.18	QP
3	0.41	-18.02	0.05	9.85	-8.12	47.68	-55.80	Average
4	0.41	-13.49	0.05	9.85	-3.59	57.68	-61.27	QP
5	0.88	-18.28	0.05	9.88	-8.35	46.00	-54.35	Average
6	0.88	-13.57	0.05	9.88	-3.64	56.00	-59.64	QP
7	1.96	-17.69	0.06	9.86	-7.77	46.00	-53.77	Average
8	1.96	-12.82	0.06	9.86	-2.90	56.00	-58.90	QP
9	4.36	-16.32	0.08	9.83	-6.41	46.00	-52.41	Average
10	4.36	-11.52	0.08	9.83	-1.61	56.00	-57.61	QP
11	7.29	-15.51	0.13	9.83	-5.55	50.00	-55.55	Average
12	7.29	-11.19	0.13	9.83	-1.23	60.00	-61.23	QP

Notes: Emission Level = Read Level + LISN Factor + Cable loss

Mode:b; Line:Live Line

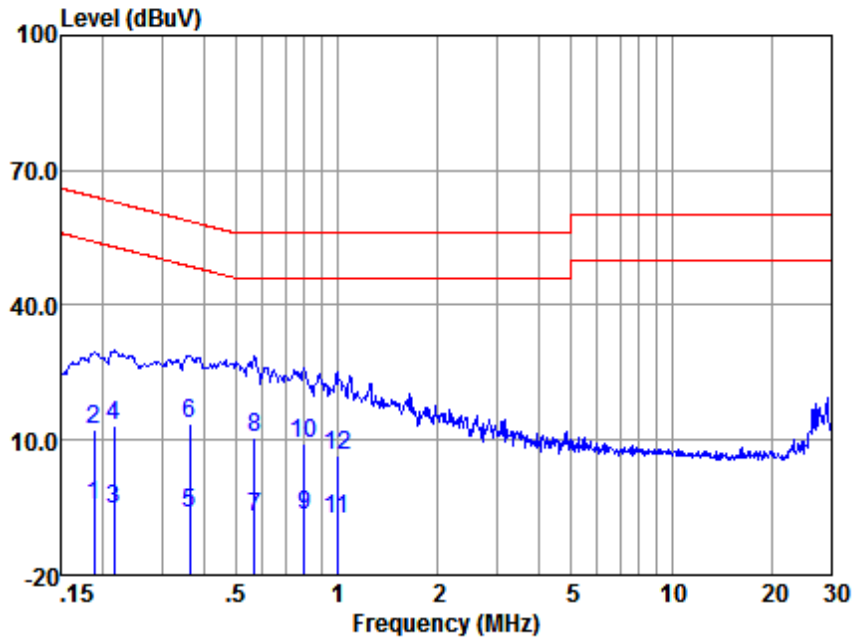

LISN : LINE
 EUT/Project No : 8776TX
 Test mode : b

	Freq (MHz)	Read level (dBuV)	LISN Factor (dB)	Cable Loss (dB)	Emission Level (dBuV)	Limit (dBuV)	Over Limit (dB)	Remark
1	0.19	-14.49	0.05	9.83	-4.61	54.15	-58.76	Average
2	0.19	2.37	0.05	9.83	12.25	64.15	-51.90	QP
3	0.22	-15.20	0.05	9.83	-5.32	53.01	-58.33	Average
4	0.22	3.18	0.05	9.83	13.06	63.01	-49.95	QP
5	0.36	-16.17	0.05	9.84	-6.28	48.69	-54.97	Average
6	0.36	3.94	0.05	9.84	13.83	58.69	-44.86	QP
7	0.57	-16.76	0.05	9.76	-6.95	46.00	-52.95	Average
8	0.57	0.91	0.05	9.76	10.72	56.00	-45.28	QP
9	0.80	-16.80	0.04	9.86	-6.90	46.00	-52.90	Average
10	0.80	-0.69	0.04	9.86	9.21	56.00	-46.79	QP
11	1.00	-17.20	0.05	9.77	-7.38	46.00	-53.38	Average
12	1.00	-3.32	0.05	9.77	6.50	56.00	-49.50	QP

Notes: Emission Level = Read Level + LISN Factor + Cable loss

Mode:b; Line:Neutral Line

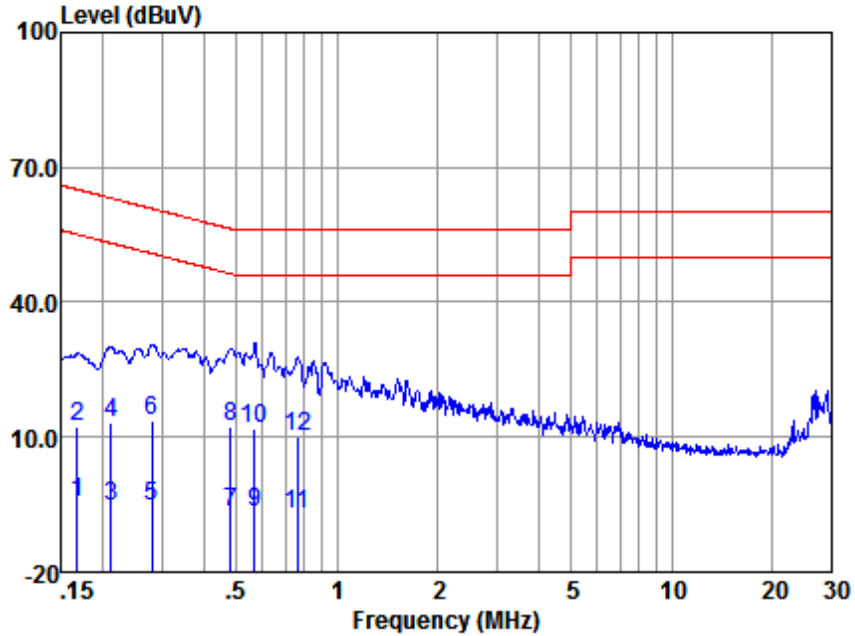

LISN : NEUTRAL
 EUT/Project No : 8776TX
 Test mode : b

Freq (MHz)	Read level (dBUV)	LISN Factor (dB)	Cable Loss (dB)	Emission Level (dBUV)	Limit (dBUV)	Over Limit (dB)	Remark	
1	0.17	-14.39	0.06	9.83	-4.50	55.08	-59.58	Average
2	0.17	2.35	0.06	9.83	12.24	65.08	-52.84	QP
3	0.21	-15.12	0.06	9.83	-5.23	53.18	-58.41	Average
4	0.21	3.43	0.06	9.83	13.32	63.18	-49.86	QP
5	0.28	-15.27	0.06	9.85	-5.36	50.81	-56.17	Average
6	0.28	3.73	0.06	9.85	13.64	60.81	-47.17	QP
7	0.48	-16.62	0.05	9.81	-6.76	46.32	-53.08	Average
8	0.48	2.64	0.05	9.81	12.50	56.32	-43.82	QP
9	0.57	-16.48	0.05	9.76	-6.67	46.00	-52.67	Average
10	0.57	2.16	0.05	9.76	11.97	56.00	-44.03	QP
11	0.76	-16.98	0.05	9.86	-7.07	46.00	-53.07	Average
12	0.76	0.30	0.05	9.86	10.21	56.00	-45.79	QP

Notes: Emission Level = Read Level + LISN Factor + Cable loss

Mode:c; Line:Live Line

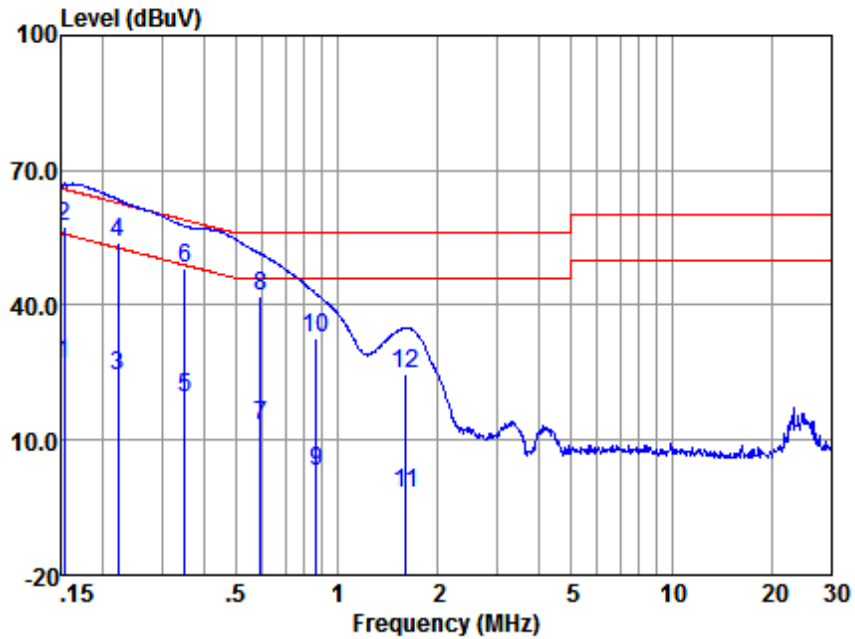

LISN : LINE
 EUT/Project No : 8776TX
 Test mode : c

	Freq (MHz)	Read level (dBuV)	LISN Factor (dB)	Cable Loss (dB)	Emission Level (dBuV)	Limit (dBuV)	Over Limit (dB)	Remark
1	0.15	16.86	0.05	9.82	26.73	55.87	-29.14	Average
2	0.15	47.76	0.05	9.82	57.63	65.87	-8.24	QP
3	0.22	14.45	0.05	9.84	24.34	52.74	-28.40	Average
4	0.22	43.84	0.05	9.84	53.73	62.74	-9.01	QP
5	0.35	9.45	0.05	9.84	19.34	48.96	-29.62	Average
6	0.35	38.28	0.05	9.84	48.17	58.96	-10.79	QP
7	0.59	3.34	0.05	9.77	13.16	46.00	-32.84	Average
8	0.59	32.22	0.05	9.77	42.04	56.00	-13.96	QP
9	0.87	-6.77	0.05	9.87	3.15	46.00	-42.85	Average
10	0.87	22.63	0.05	9.87	32.55	56.00	-23.45	QP
11	1.61	-11.80	0.05	9.89	-1.86	46.00	-47.86	Average
12	1.61	14.76	0.05	9.89	24.70	56.00	-31.30	QP

Notes: Emission Level = Read Level + LISN Factor + Cable loss

Mode:c; Line:Neutral Line

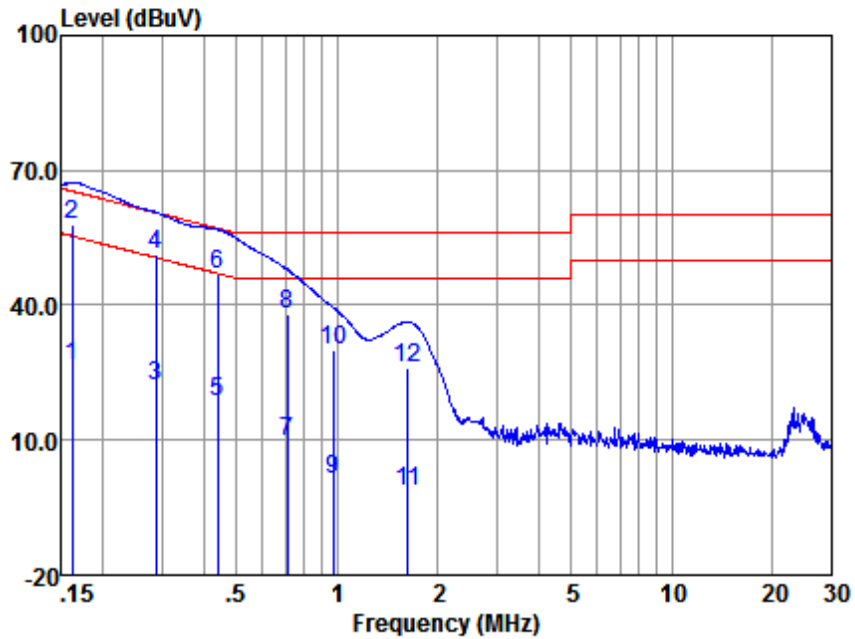

LISN : NEUTRAL
 EUT/Project No : 8776TX
 Test mode : c

	Freq (MHz)	Read level (dBuV)	LISN Factor (dB)	Cable Loss (dB)	Emission Level (dBuV)	Limit (dBuV)	Over Limit (dB)	Remark
1	0.16	16.72	0.06	9.82	26.60	55.38	-28.78	Average
2	0.16	48.01	0.06	9.82	57.89	65.38	-7.49	QP
3	0.29	12.36	0.06	9.85	22.27	50.59	-28.32	Average
4	0.29	41.24	0.06	9.85	51.15	60.59	-9.44	QP
5	0.44	8.66	0.05	9.84	18.55	47.07	-28.52	Average
6	0.44	37.09	0.05	9.84	46.98	57.07	-10.09	QP
7	0.71	-0.19	0.05	9.85	9.71	46.00	-36.29	Average
8	0.71	28.30	0.05	9.85	38.20	56.00	-17.80	QP
9	0.97	-8.47	0.05	9.78	1.36	46.00	-44.64	Average
10	0.97	20.38	0.05	9.78	30.21	56.00	-25.79	QP
11	1.63	-11.16	0.06	9.88	-1.22	46.00	-47.22	Average
12	1.63	16.14	0.06	9.88	26.08	56.00	-29.92	QP

Notes: Emission Level = Read Level + LISN Factor + Cable loss

Mode:d; Line:Live Line

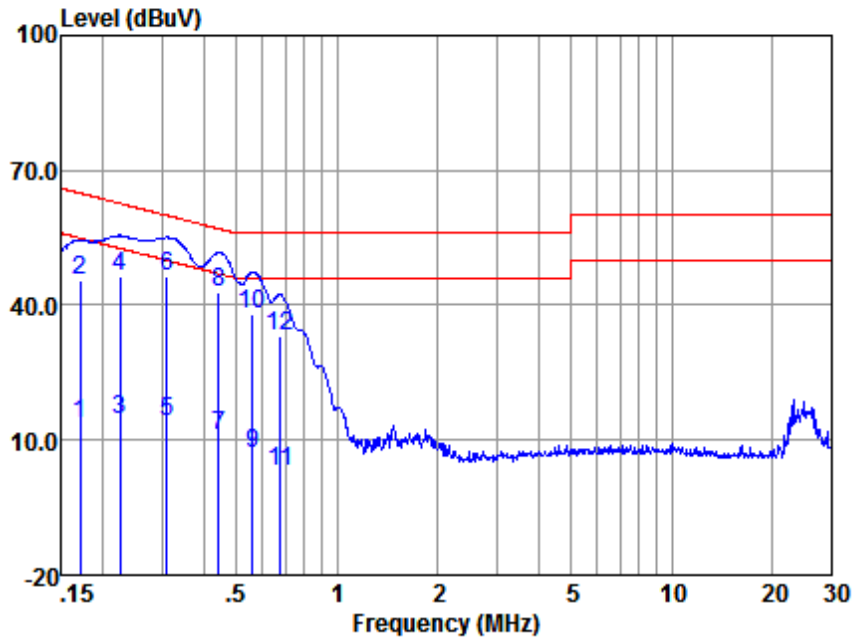

LISN : LINE
 EUT/Project No : 8776TX
 Test mode : d

	Freq (MHz)	Read level (dBuV)	LISN Factor (dB)	Cable Loss (dB)	Emission Level (dBuV)	Limit (dBuV)	Over Limit (dB)	Remark
1	0.17	3.82	0.05	9.83	13.70	54.94	-41.24	Average
2	0.17	35.53	0.05	9.83	45.41	64.94	-19.53	QP
3	0.22	4.72	0.05	9.84	14.61	52.66	-38.05	Average
4	0.22	36.65	0.05	9.84	46.54	62.66	-16.12	QP
5	0.31	4.26	0.05	9.84	14.15	49.97	-35.82	Average
6	0.31	36.35	0.05	9.84	46.24	59.97	-13.73	QP
7	0.44	1.14	0.05	9.84	11.03	47.02	-35.99	Average
8	0.44	32.83	0.05	9.84	42.72	57.02	-14.30	QP
9	0.56	-2.70	0.05	9.76	7.11	46.00	-38.89	Average
10	0.56	28.10	0.05	9.76	37.91	56.00	-18.09	QP
11	0.68	-6.74	0.04	9.85	3.15	46.00	-42.85	Average
12	0.68	23.14	0.04	9.85	33.03	56.00	-22.97	QP

Notes: Emission Level = Read Level + LISN Factor + Cable loss

Mode:d; Line:Neutral Line

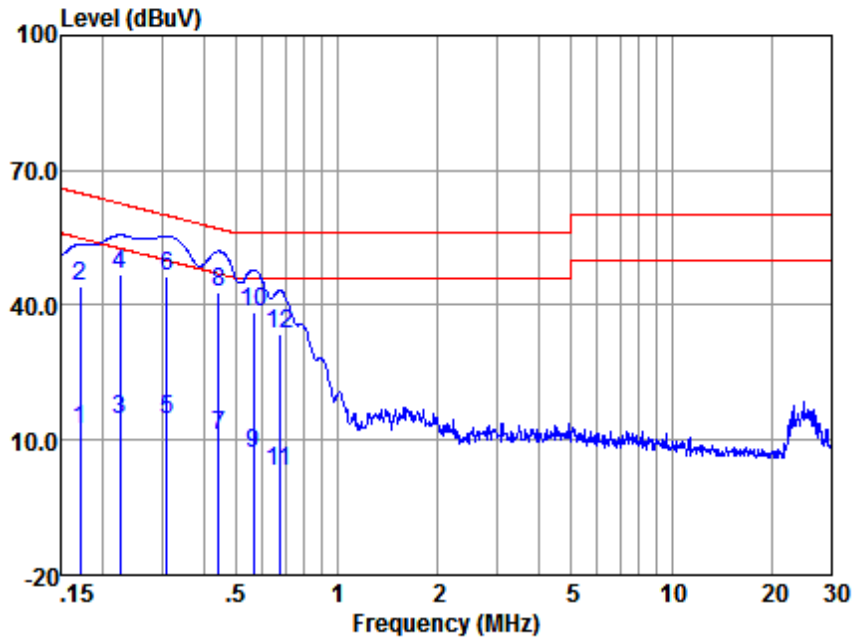

LISN : NEUTRAL
 EUT/Project No : 8776TX
 Test mode : d

	Freq (MHz)	Read level (dBuV)	LISN Factor (dB)	Cable Loss (dB)	Emission Level (dBuV)	Limit (dBuV)	Over Limit (dB)	Remark
1	0.17	2.64	0.06	9.83	12.53	54.94	-42.41	Average
2	0.17	34.44	0.06	9.83	44.33	64.94	-20.61	QP
3	0.22	4.79	0.06	9.84	14.69	52.66	-37.97	Average
4	0.22	36.89	0.06	9.84	46.79	62.66	-15.87	QP
5	0.31	4.53	0.06	9.84	14.43	49.97	-35.54	Average
6	0.31	36.70	0.06	9.84	46.60	59.97	-13.37	QP
7	0.44	1.14	0.05	9.84	11.03	47.02	-35.99	Average
8	0.44	32.97	0.05	9.84	42.86	57.02	-14.16	QP
9	0.56	-2.64	0.05	9.76	7.17	46.00	-38.83	Average
10	0.56	28.47	0.05	9.76	38.28	56.00	-17.72	QP
11	0.67	-6.93	0.05	9.85	2.97	46.00	-43.03	Average
12	0.67	23.57	0.05	9.85	33.47	56.00	-22.53	QP

Notes: Emission Level = Read Level + LISN Factor + Cable loss

Mode:e; Line:Live Line

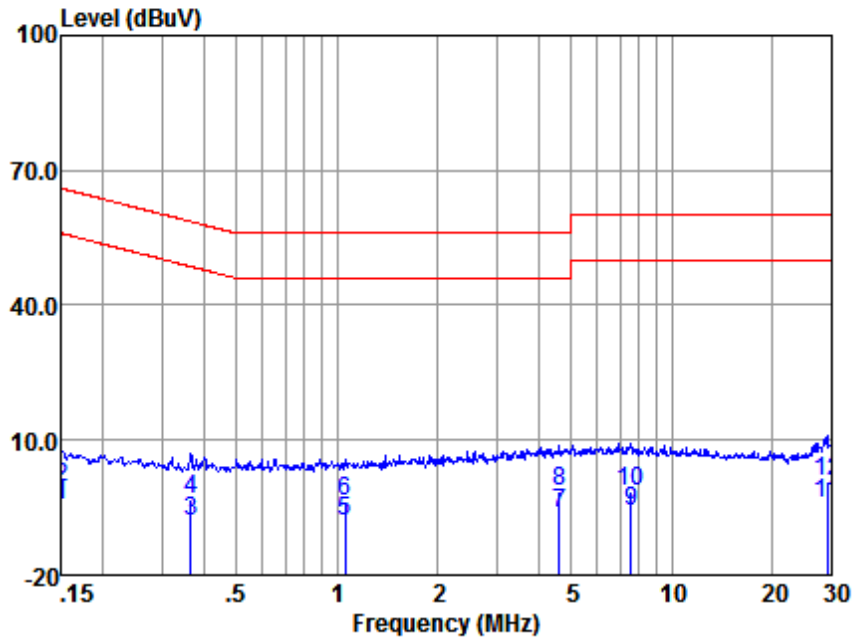

LISN : LINE
 EUT/Project No : 8776TX
 Test mode : e

	Freq (MHz)	Read level (dBuV)	LISN Factor (dB)	Cable Loss (dB)	Emission Level (dBuV)	Limit (dBuV)	Over Limit (dB)	Remark
1	0.15	-14.47	0.05	9.82	-4.60	56.00	-60.60	Average
2	0.15	-10.32	0.05	9.82	-0.45	66.00	-66.45	QP
3	0.37	-18.00	0.05	9.84	-8.11	48.61	-56.72	Average
4	0.37	-13.27	0.05	9.84	-3.38	58.61	-61.99	QP
5	1.05	-17.93	0.05	9.80	-8.08	46.00	-54.08	Average
6	1.05	-13.61	0.05	9.80	-3.76	56.00	-59.76	QP
7	4.62	-15.99	0.08	9.85	-6.06	46.00	-52.06	Average
8	4.62	-11.36	0.08	9.85	-1.43	56.00	-57.43	QP
9	7.57	-15.89	0.13	9.85	-5.91	50.00	-55.91	Average
10	7.57	-11.40	0.13	9.85	-1.42	60.00	-61.42	QP
11	29.18	-14.81	0.47	10.41	-3.93	50.00	-53.93	Average
12	29.18	-9.95	0.47	10.41	0.93	60.00	-59.07	QP

Notes: Emission Level = Read Level + LISN Factor + Cable loss

Mode:e; Line:Neutral Line

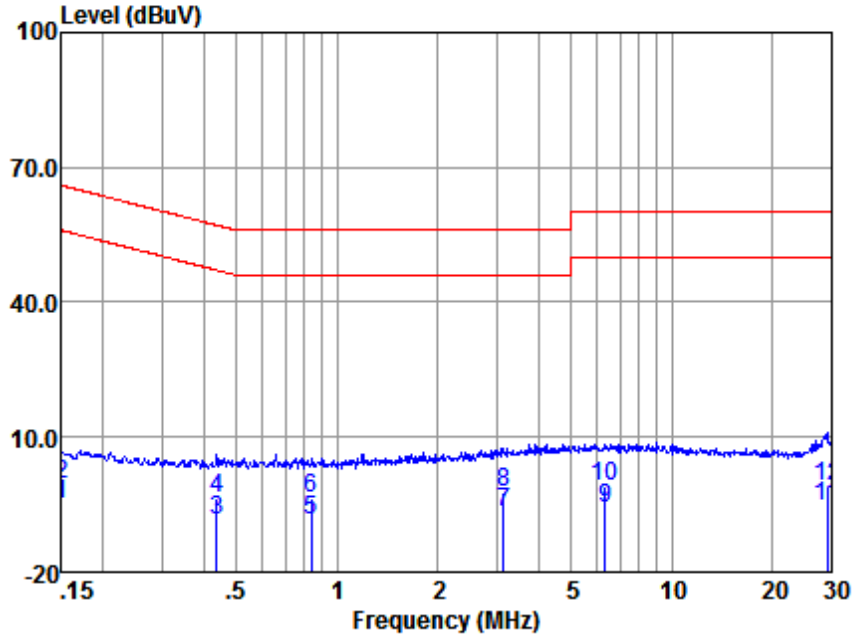

LISN : NEUTRAL
 EUT/Project No : 8776TX
 Test mode : e

	Freq (MHz)	Read level (dBuV)	LISN Factor (dB)	Cable Loss (dB)	Emission Level (dBuV)	Limit (dBuV)	Over Limit (dB)	Remark
1	0.15	-14.84	0.06	9.82	-4.96	56.00	-60.96	Average
2	0.15	-10.19	0.06	9.82	-0.31	66.00	-66.31	QP
3	0.44	-18.35	0.05	9.84	-8.46	47.11	-55.57	Average
4	0.44	-13.51	0.05	9.84	-3.62	57.11	-60.73	QP
5	0.84	-18.19	0.05	9.86	-8.28	46.00	-54.28	Average
6	0.84	-13.68	0.05	9.86	-3.77	56.00	-59.77	QP
7	3.16	-16.62	0.07	9.86	-6.69	46.00	-52.69	Average
8	3.16	-12.19	0.07	9.86	-2.26	56.00	-58.26	QP
9	6.32	-15.79	0.11	9.85	-5.83	50.00	-55.83	Average
10	6.32	-10.89	0.11	9.85	-0.93	60.00	-60.93	QP
11	29.22	-16.15	0.47	10.41	-5.27	50.00	-55.27	Average
12	29.22	-11.73	0.47	10.41	-0.85	60.00	-60.85	QP

Notes: Emission Level = Read Level + LISN Factor + Cable loss

6.2 Radiated Emissions (30MHz-1GHz)

Test Requirement: EN 61000-6-3:2007 +A1:2011
 Test Method: CISPR 16-2-3
 Frequency Range: 30MHz to 1GHz
 Measurement Distance: 3m
 Limit:
 30MHz-230MHz 40 dB(μ V/m) quasi-peak
 230MHz-1GHz 47 dB(μ V/m) quasi-peak
 Detector: Peak for pre-scan (120kHz resolution bandwidth) 30M to 1000MHz

6.2.1 E.U.T. Operation

Operating Environment:

Temperature: 22 °C Humidity: 50 % RH Atmospheric Pressure: 1020 mbar

Test mode:
 a: Keep mode CDB092A running with AC220V,
 b: Keep mode CDB092E running with AC24V,
 c: Keep mode CDB092B running with DC24V,
 d: Keep mode CDB092F running with DC12V,
 e: Keep mode CDB092C running with AC110V.

6.2.2 Test Setup Diagram

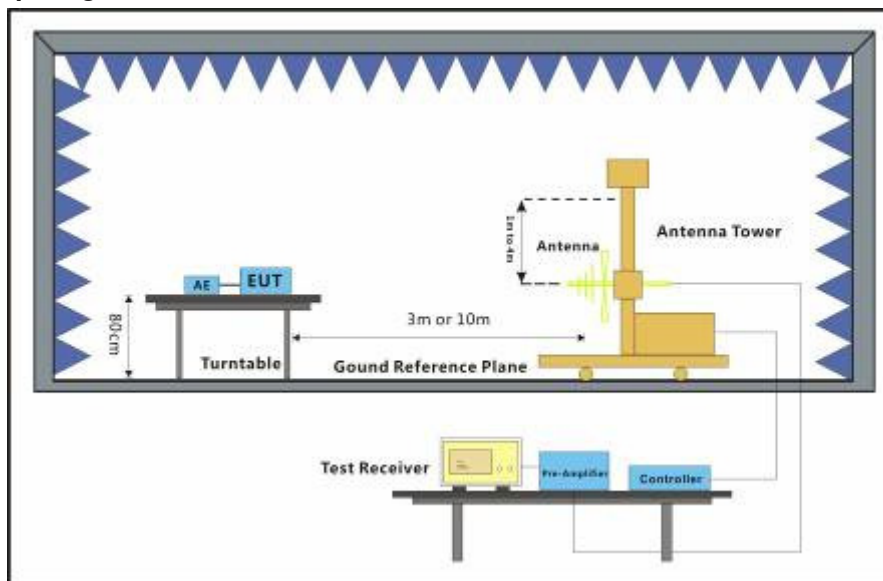

6.2.3 Measurement Data

An initial pre-scan was performed in the chamber using the spectrum analyser in peak detection mode. Quasi-peak measurements were conducted based on the peak sweep graph. The EUT was measured by BiConiLog antenna with 2 orthogonal polarities.

Mode:a; Polarization:Horizontal

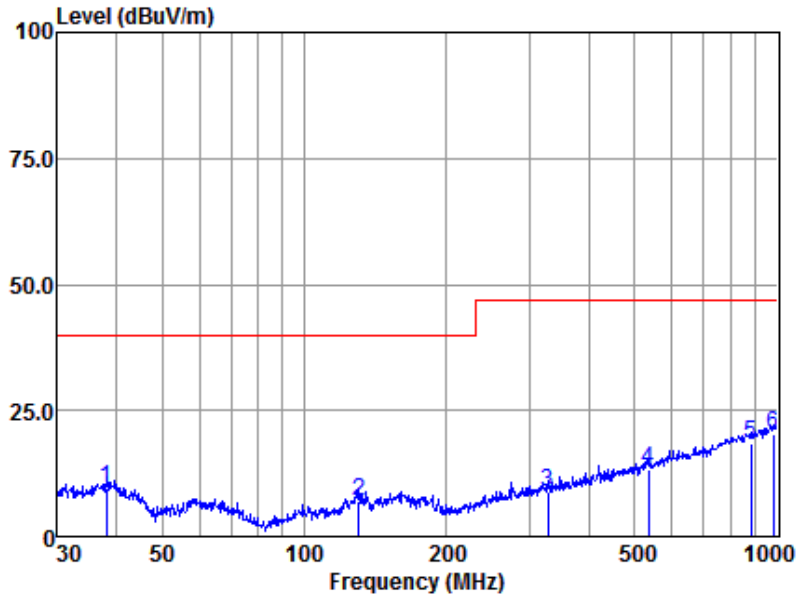

Antenna Polarity :HORIZONTAL
 EUT/Project :8776TX
 Test mode :a

	Read	Antenna	Cable	Preamp	Emission	Limit	Over	
Freq	Level	Factor	Loss	Factor	Level	Line	Limit	Remark
MHz	dBuv	dB/m	dB	dB	dBuv/m	dBuv/m	dB	
1	38.08	35.95	16.13	0.22	42.62	9.68	40.00	-30.32 QP
2	130.38	36.52	12.73	0.58	42.65	7.18	40.00	-32.82 QP
3	327.89	36.53	13.78	0.89	42.31	8.89	47.00	-38.11 QP
4	535.71	36.10	18.05	1.25	42.16	13.24	47.00	-33.76 QP
5	881.41	35.74	22.56	2.35	42.05	18.60	47.00	-28.40 QP
6	982.62	35.24	23.62	2.76	41.30	20.32	47.00	-26.68 QP

Note:Emission Level=Read Level+Antenna Factor+Cable loss-Preamp Factor

Mode:a; Polarization:Vertical

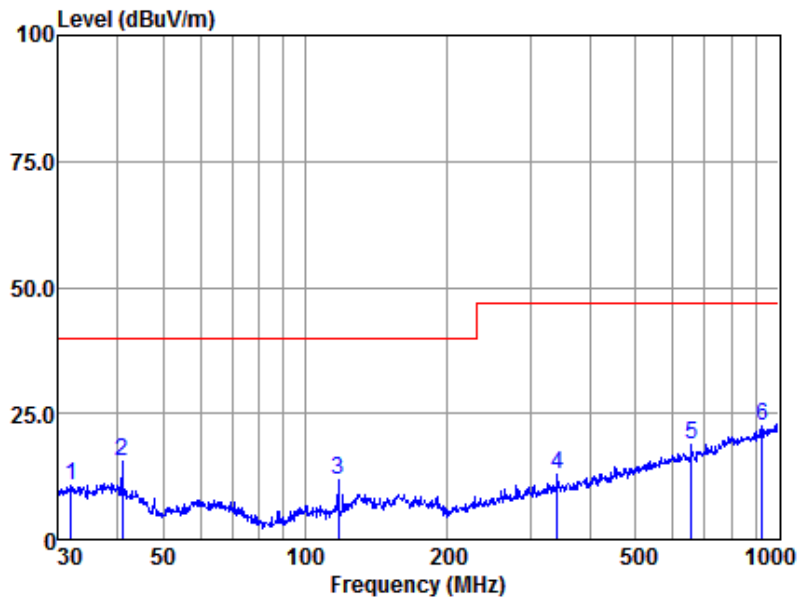

Antenna Polarity :VERTICAL
 EUT/Project :8776TX
 Test mode :a

	Read	Antenna	Cable	Preamp	Emission	Limit	Over	
Freq	Level	Factor	Loss	Factor	Level	Line	Limit	Remark
MHz	dBuv	dB/m	dB	dB	dBuv/m	dBuv/m	dB	
1	31.95	37.42	15.52	0.19	42.61	10.52	40.00	-29.48 QP
2	40.99	42.04	15.68	0.23	42.62	15.33	40.00	-24.67 QP
3	117.36	44.19	9.90	0.53	42.69	11.93	40.00	-28.07 QP
4	341.98	40.35	14.06	0.91	42.26	13.06	47.00	-33.94 QP
5	656.53	39.78	19.87	1.55	42.27	18.93	47.00	-28.07 QP
6	925.76	38.87	22.99	2.49	41.70	22.65	47.00	-24.35 QP

Note:Emission Level=Read Level+Antenna Factor+Cable loss-Preamp Factor



Mode:b; Polarization:Horizontal

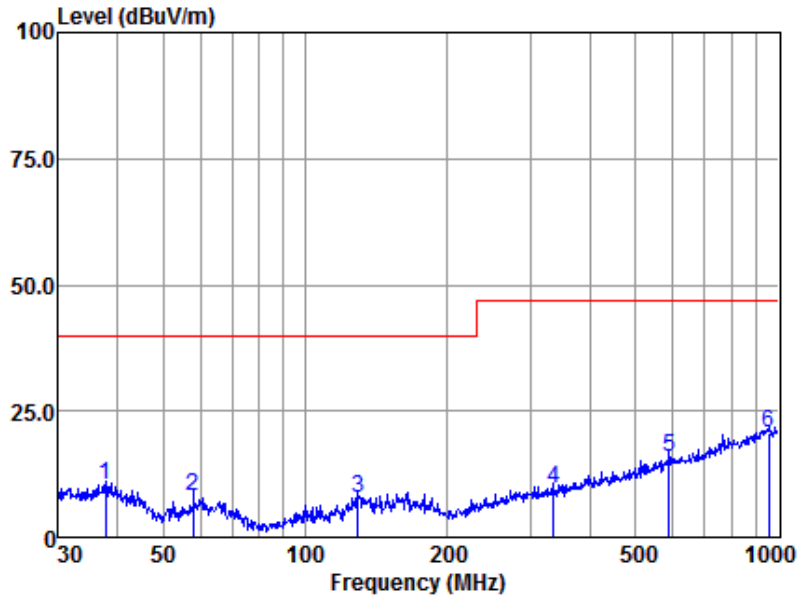

Antenna Polarity :HORIZONTAL
 EUT/Project :8776TX
 Test mode :b

	Read	Antenna	Cable	Preamp	Emission	Limit	Over	
Freq	Level	Factor	Loss	Factor	Level	Line	Limit	Remark
MHz	dBuv	dB/m	dB	dB	dBuv/m	dBuv/m	dB	
1	37.81	36.47	16.10	0.21	42.62	10.16	40.00	-29.84 QP
2	58.00	38.28	12.22	0.29	42.65	8.14	40.00	-31.86 QP
3	129.47	37.21	12.68	0.58	42.66	7.81	40.00	-32.19 QP
4	336.04	37.13	13.94	0.90	42.28	9.69	47.00	-37.31 QP
5	588.91	37.66	19.19	1.35	42.18	16.02	47.00	-30.98 QP
6	955.44	36.11	23.32	2.66	41.50	20.59	47.00	-26.41 QP

Note:Emission Level=Read Level+Antenna Factor+Cable loss-Preamp Factor

Mode:b; Polarization:Vertical

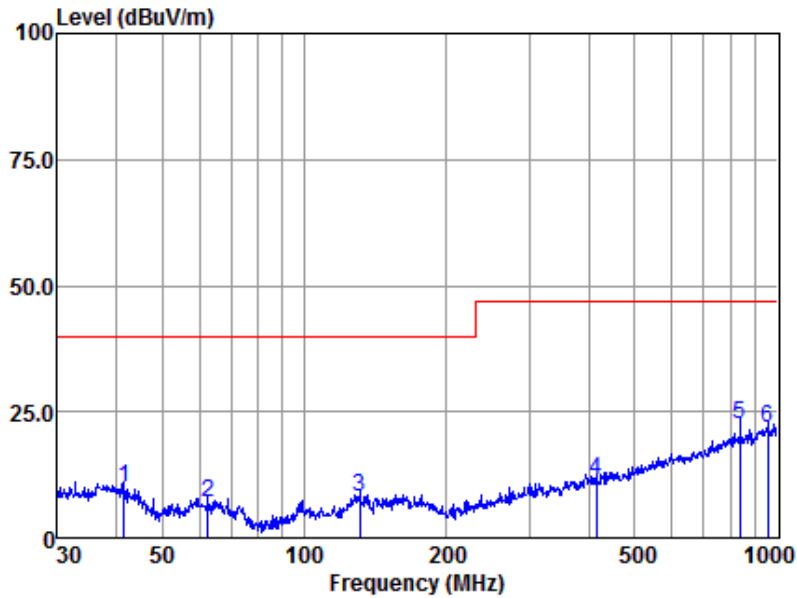

Antenna Polarity :VERTICAL
 EUT/Project :8776TX
 Test mode :b

	Read	Antenna	Cable	Preamp	Emission	Limit	Over	
Freq	Level	Factor	Loss	Factor	Level	Line	Limit	Remark
MHz	dBuv	dB/m	dB	dB	dBuv/m	dBuv/m	dB	
1	41.57	37.06	15.32	0.23	42.63	9.98	40.00	-30.02 QP
2	62.65	37.21	12.27	0.31	42.66	7.13	40.00	-32.87 QP
3	130.84	37.49	12.66	0.58	42.65	8.08	40.00	-31.92 QP
4	414.72	37.19	15.43	1.02	42.10	11.54	47.00	-35.46 QP
5	836.24	40.53	22.21	2.15	42.30	22.59	47.00	-24.41 QP
6	958.79	37.28	23.36	2.66	41.50	21.80	47.00	-25.20 QP

Note:Emission Level=Read Level+Antenna Factor+Cable loss-Preamp Factor

Mode:c; Polarization:Horizontal

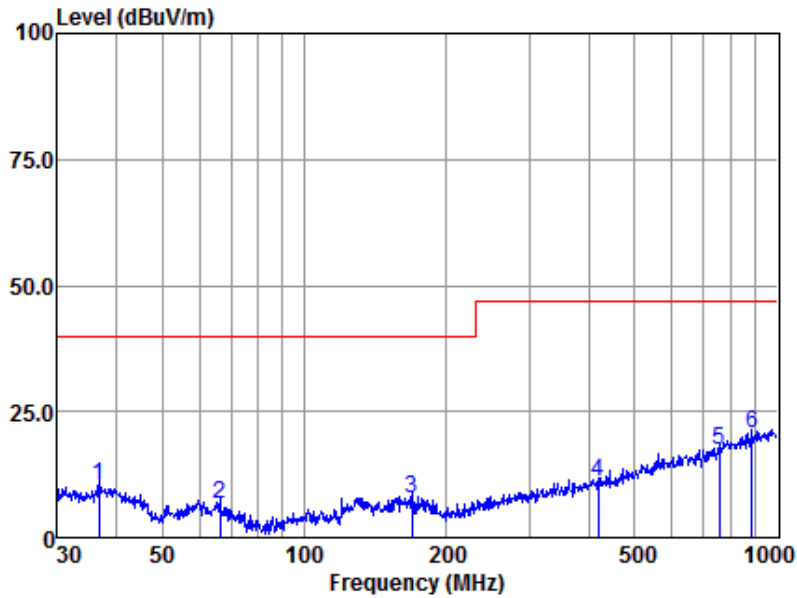

Antenna Polarity :HORIZONTAL
 EUT/Project :8776TX
 Test mode :c

	Read	Antenna	Cable	Preamp	Emission	Limit	Over	
Freq	Level	Factor	Loss	Factor	Level	Line	Limit	Remark
MHz	dBuV	dB/m	dB	dB	dBuV/m	dBuV/m	dB	
1	36.77	16.01	0.21	42.62	10.37	40.00	-29.63	QP
2	66.27	11.84	0.32	42.66	6.72	40.00	-33.28	QP
3	169.01	11.77	0.65	42.58	7.69	40.00	-32.31	QP
4	419.11	15.53	1.03	42.11	10.94	47.00	-36.06	QP
5	755.39	21.18	1.88	42.58	17.37	47.00	-29.63	QP
6	887.61	22.61	2.42	42.00	20.56	47.00	-26.44	QP

Note:Emission Level=Read Level+Antenna Factor+Cable loss-Preamp Factor



Mode:c; Polarization:Vertical

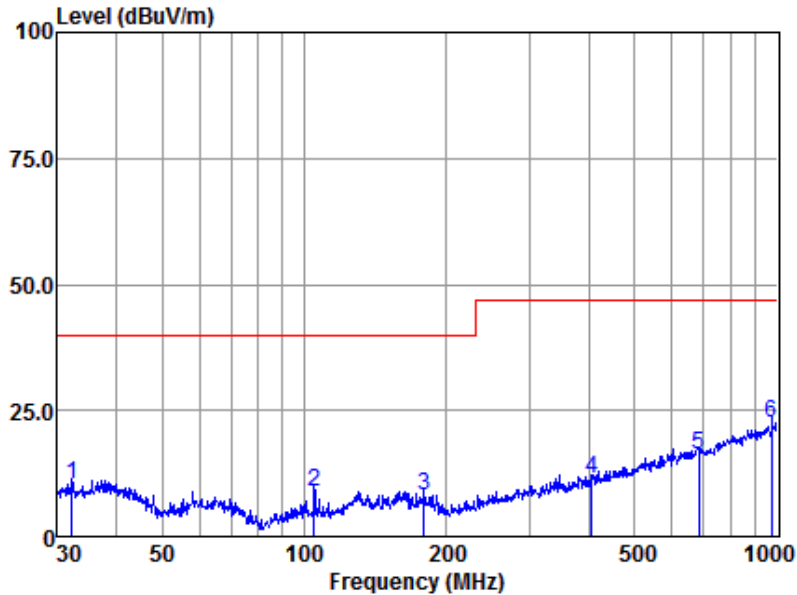

Antenna Polarity :VERTICAL
 EUT/Project :8776TX
 Test mode :c

	Read	Antenna	Cable	Preamp	Emission	Limit	Over	
Freq	Level	Factor	Loss	Factor	Level	Line	Limit	Remark
MHz	dBuv	dB/m	dB	dB	dBuv/m	dBuv/m	dB	
1	32.29	37.35	15.56	0.19	42.61	10.49	40.00	-29.51 QP
2	104.90	41.47	9.55	0.47	42.69	8.80	40.00	-31.20 QP
3	179.39	38.11	11.88	0.66	42.56	8.09	40.00	-31.91 QP
4	406.09	37.12	15.23	1.01	42.10	11.26	47.00	-35.74 QP
5	682.35	36.99	20.07	1.61	42.36	16.31	47.00	-30.69 QP
6	975.75	37.62	23.54	2.69	41.35	22.50	47.00	-24.50 QP

Note:Emission Level=Read Level+Antenna Factor+Cable loss-Preamp Factor



Mode:d; Polarization:Horizontal

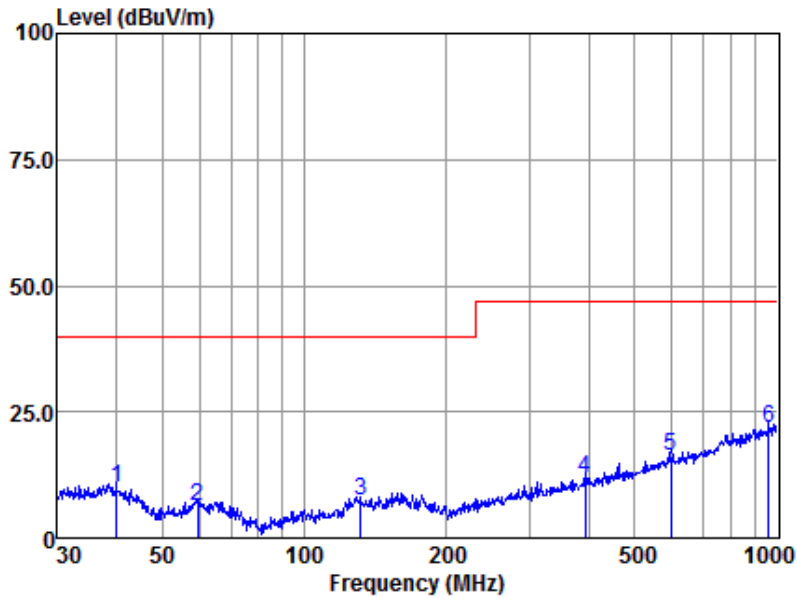

Antenna Polarity :HORIZONTAL
 EUT/Project :8776TX
 Test mode :d

	Read	Antenna	Cable	Preamp	Emission	Limit	Over	
Freq	Level	Factor	Loss	Factor	Level	Line	Limit	Remark
-----	-----	-----	-----	-----	-----	-----	-----	-----
MHz	dBuv	dB/m	dB	dB	dBuv/m	dBuv/m	dB	
1	39.99	36.10	16.30	0.22	42.62	10.00	40.00	-30.00 QP
2	59.44	36.18	12.48	0.30	42.65	6.31	40.00	-33.69 QP
3	131.76	36.80	12.51	0.58	42.65	7.24	40.00	-32.76 QP
4	393.47	37.90	14.98	0.98	42.12	11.74	47.00	-35.26 QP
5	597.22	37.85	19.36	1.36	42.18	16.39	47.00	-30.61 QP
6	962.16	37.25	23.40	2.66	41.45	21.86	47.00	-25.14 QP

Note:Emission Level=Read Level+Antenna Factor+Cable loss-Preamp Factor

Mode:d; Polarization:Vertical

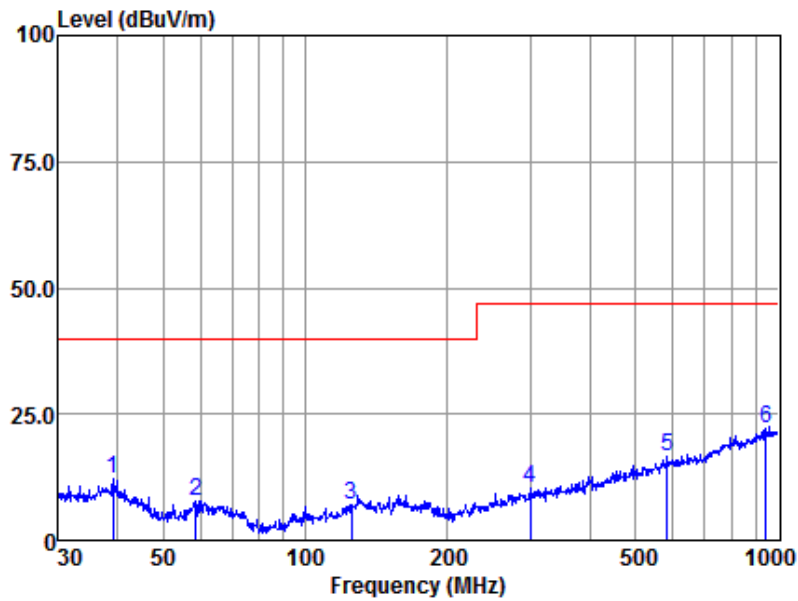

Antenna Polarity :VERTICAL
 EUT/Project :8776TX
 Test mode :d

	Read	Antenna	Cable	Preamp	Emission	Limit	Over	
Freq	Level	Factor	Loss	Factor	Level	Line	Limit	Remark
MHz	dBuV	dB/m	dB	dB	dBuV/m	dBuV/m	dB	
1	39.16	38.34	16.23	0.22	42.62	12.17	40.00	-27.83 QP
2	58.61	37.93	12.33	0.29	42.65	7.90	40.00	-32.10 QP
3	125.01	37.84	11.46	0.55	42.67	7.18	40.00	-32.82 QP
4	299.32	38.80	13.17	0.84	42.40	10.41	47.00	-36.59 QP
5	582.74	38.32	19.06	1.35	42.18	16.55	47.00	-30.45 QP
6	945.44	37.72	23.21	2.63	41.55	22.01	47.00	-24.99 QP

Note:Emission Level=Read Level+Antenna Factor+Cable loss-Preamp Factor

Mode:e; Polarization:Horizontal

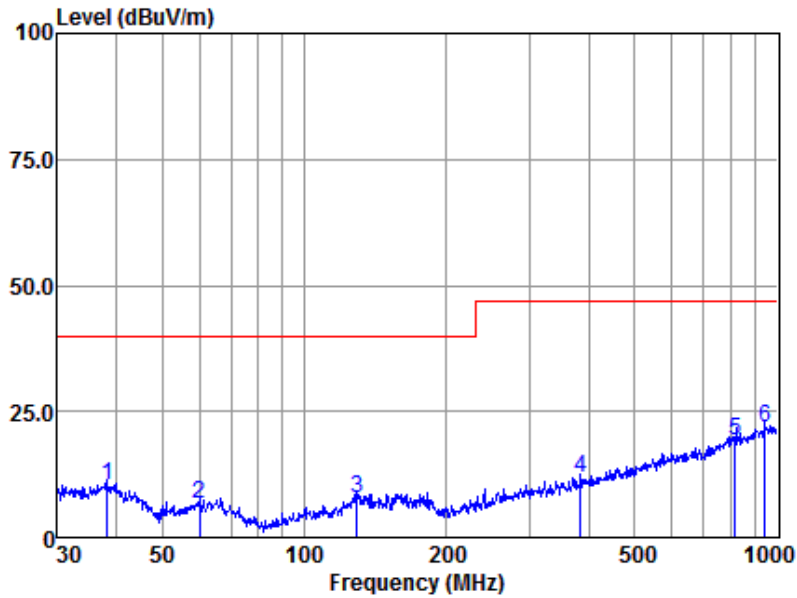

Antenna Polarity :HORIZONTAL
 EUT/Project :8776TX
 Test mode :e

	Read	Antenna	Cable	Preamp	Emission	Limit	Over	
Freq	Level	Factor	Loss	Factor	Level	Line	Limit	Remark
MHz	dBuv	dB/m	dB	dB	dBuv/m	dBuv/m	dB	
1	38.21	36.56	16.14	0.22	42.62	10.30	40.00	-29.70 QP
2	60.07	36.51	12.60	0.30	42.65	6.76	40.00	-33.24 QP
3	129.47	37.25	12.68	0.58	42.66	7.85	40.00	-32.15 QP
4	383.93	38.07	14.82	0.97	42.14	11.72	47.00	-35.28 QP
5	815.97	37.26	22.04	2.11	42.38	19.03	47.00	-27.97 QP
6	945.44	37.49	23.21	2.63	41.55	21.78	47.00	-25.22 QP

Note:Emission Level=Read Level+Antenna Factor+Cable loss-Preamp Factor

Mode:e; Polarization:Vertical

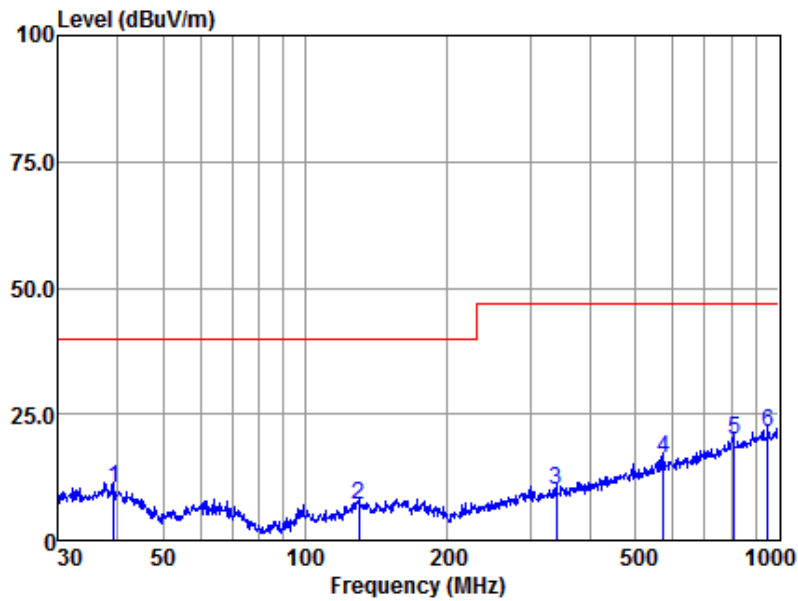

Antenna Polarity :VERTICAL
 EUT/Project :8776TX
 Test mode :e

	Read	Antenna	Cable	Preamp	Emission	Limit	Over	
Freq	Level	Factor	Loss	Factor	Level	Line	Limit	Remark
MHz	dBuV	dB/m	dB	dB	dBuV/m	dBuV/m	dB	
1	39.30	36.42	16.24	0.22	42.62	10.26	40.00	-29.74 QP
2	129.92	36.26	12.80	0.58	42.65	6.99	40.00	-33.01 QP
3	339.59	37.29	14.01	0.90	42.27	9.93	47.00	-37.07 QP
4	572.61	38.19	18.85	1.31	42.18	16.17	47.00	-30.83 QP
5	807.43	38.24	21.97	2.08	42.40	19.89	47.00	-27.11 QP
6	952.09	37.04	23.29	2.63	41.50	21.46	47.00	-25.54 QP

Note:Emission Level=Read Level+Antenna Factor+Cable loss-Preamp Factor



6.3 Harmonic Current Emission

Test Requirement: EN 61000-6-3:2007 +A1:2011

Test Method: EN 61000-3-2:2014

Frequency Range: 100Hz to 2kHz

There is no need for Harmonics test to be performed on this product (rated power is less than 75W) in accordance with EN 61000-3-2:2014.

For further details, please refer to Clause 7 of EN 61000-3-2 which states:

"For the following categories of equipment, limits are not specified in this standard.- equipment with a rated power of 75W or less, other than lighting equipment."

6.4 Voltage Fluctuations and Flicker

Test Requirement: EN 61000-6-3:2007 +A1:2011

Test Method: EN 61000-3-3:2013

6.4.1 E.U.T. Operation

Operating Environment:

Temperature: 22 °C Humidity: 50 % RH Atmospheric Pressure: 1020 mbar

Test mode:
 a: Keep mode CDB092A running with AC220V,
 b: Keep mode CDB092E running with AC24V,
 c: Keep mode CDB092B running with DC24V,
 d: Keep mode CDB092F running with DC12V,
 e: Keep mode CDB092C running with AC110V.

6.4.2 Test Setup Diagram

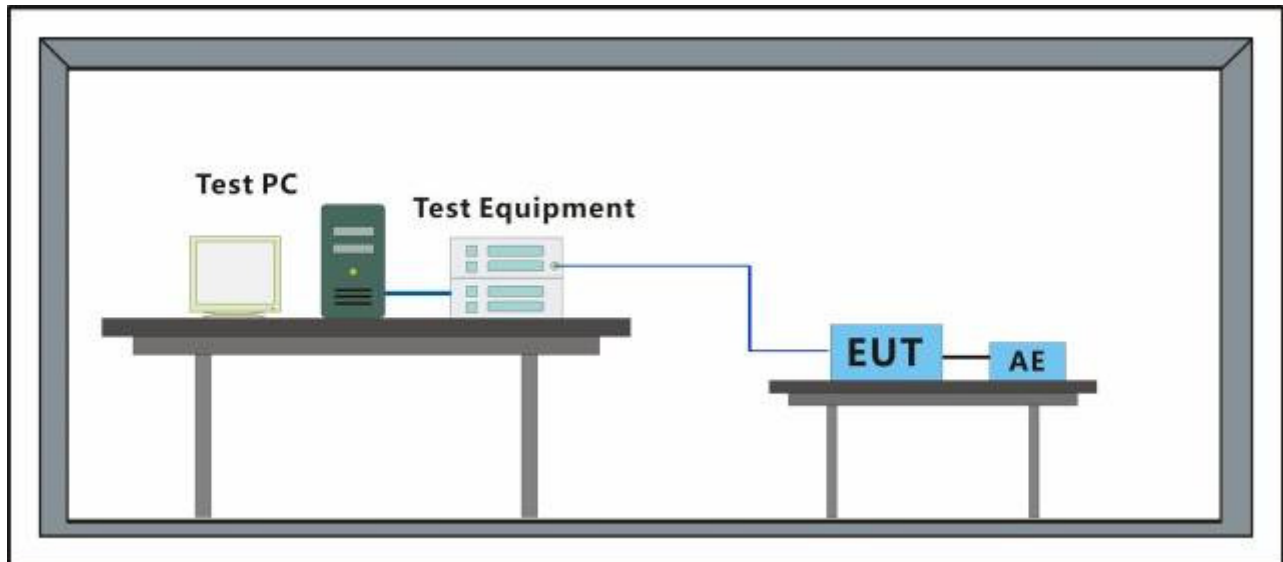

6.4.3 Measurement Data

Mode:a

Vrms at the end of test (Volt):	219.98			
T-max (mS):	0	Test limit (mS):	500.0	Pass
Highest dc (%):	0.00	Test limit (%):	3.30	Pass
Highest dmax (%):	0.00	Test limit (%):	4.00	Pass
Highest Pst (10 min. period):	0.225	Test limit:	1.000	Pass
Highest Plt (2 hr. period):	0.096	Test limit:	0.650	Pass

Mode:b

Vrms at the end of test (Volt):	24.06			
T-max (mS):	0	Test limit (mS):	500.0	Pass
Highest dc (%):	0.00	Test limit (%):	3.30	Pass
Highest dmax (%):	0.35	Test limit (%):	4.00	Pass
Highest Pst (10 min. period):	0.361	Test limit:	1.000	Pass
Highest Plt (2 hr. period):	0.155	Test limit:	0.650	Pass



Mode:c

Vrms at the end of test (Volt):	230.02			
T-max (mS):	0	Test limit (mS):	500.0	Pass
Highest dc (%):	0.00	Test limit (%):	3.30	Pass
Highest dmax (%):	0.00	Test limit (%):	4.00	Pass
Highest Pst (10 min. period):	0.219	Test limit:	1.000	Pass
Highest Plt (2 hr. period):	0.088	Test limit:	0.650	Pass

Mode:d

Vrms at the end of test (Volt):	229.92			
T-max (mS):	0	Test limit (mS):	500.0	Pass
Highest dc (%):	0.00	Test limit (%):	3.30	Pass
Highest dmax (%):	0.00	Test limit (%):	4.00	Pass
Highest Pst (10 min. period):	0.224	Test limit:	1.000	Pass
Highest Plt (2 hr. period):	0.092	Test limit:	0.650	Pass

Mode:e

Vrms at the end of test (Volt):	110.01			
T-max (mS):	0	Test limit (mS):	500.0	Pass
Highest dc (%):	0.00	Test limit (%):	3.30	Pass
Highest dmax (%):	0.00	Test limit (%):	4.00	Pass
Highest Pst (10 min. period):	0.249	Test limit:	1.000	Pass
Highest Plt (2 hr. period):	0.103	Test limit:	0.650	Pass

7 Immunity Test Results

7.1 Performance Criteria Description in EN 61000-6-1:2007

- Criterion A** The apparatus shall continue to operate as intended during and after the test. No degradation of performance or loss of function is allowed below a performance level specified by the manufacturer, when the apparatus is used as intended. The performance level may be replaced by a permissible loss of performance. If the minimum performance level or the permissible performance loss is not specified by the manufacturer, either of these may be derived from the product description and documentation and what the user may reasonably expect from the apparatus if used as intended.
- Criterion B** The apparatus shall continue to operate as intended after the test. No degradation of performance or loss of function is allowed below a performance level specified by the manufacturer, when the apparatus is used as intended. The performance level may be replaced by a permissible loss of performance. During the test, degradation of performance is however allowed. No change of actual operating state or stored data is allowed. If the minimum performance level or the permissible performance loss is not specified by the manufacturer, either of these may be derived from the product description and documentation and what the user may reasonably expect from the apparatus if used as intended.
- Criterion C** Temporary loss of function is allowed, provided the function is self-recoverable or can be restored by the operation of the controls.

7.2 Electrostatic Discharge

Test Requirement:	EN 61000-6-1:2007
Test Method:	EN 61000-4-2:2009
Performance Criterion:	B
Discharge Impedance:	330Ω/150pF
Number of Discharge:	Minimum 10 times at each test point
Discharge Mode:	Single Discharge
Discharge Period:	1 second minimum

7.2.1 Test Setup Diagram

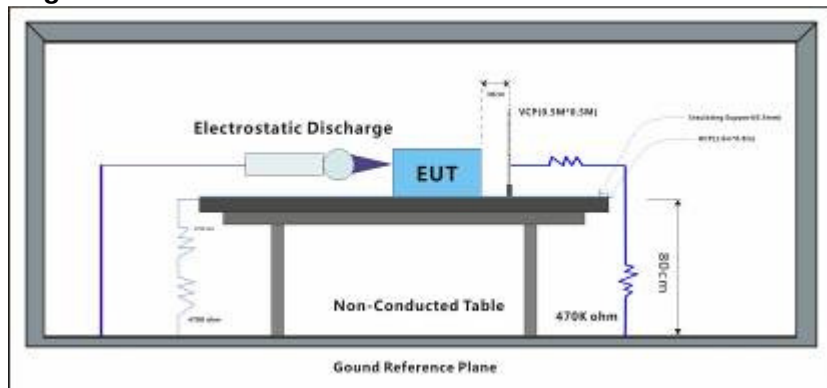

7.2.2 E.U.T. Operation

Operating Environment:

Temperature: 22 °C Humidity: 50 % RH Atmospheric Pressure: 1020 mbar

Test mode:

- a: Keep mode CDB092A running with AC220V,
- b: Keep mode CDB092E running with AC24V,
- c: Keep mode CDB092B running with DC24V,
- d: Keep mode CDB092F running with DC12V,
- e: Keep mode CDB092C running with AC110V.

7.2.3 Test Results:

Observations: Test Point:

1. All insulated enclosure and seams.
2. All accessible metal parts of the enclosure.
3. All side

Discharge type	Level (kV)	Polarity	Test Point	Result / Observations
Air Discharge	2,4,8	+	1	A
Air Discharge	2,4,8	-	1	A
Contact Discharge	4	+	2	A
Contact Discharge	4	-	2	A
Horizontal Coupling	4	+	3	A
Horizontal Coupling	4	-	3	A
Vertical Coupling	4	+	3	A
Vertical Coupling	4	-	3	A

Results:

A: No degradation in the performance of the EUT was observed.

7.3 Electrical Fast Transients/Burst at Power Port

Test Requirement: EN 61000-6-1:2007
 Test Method: EN 61000-4-4:2012
 Performance Criterion: B
 Repetition Frequency: 5kHz
 Burst Period: 300ms
 Test Duration: 2 minute per level & polarity

7.3.1 Test Setup Diagram

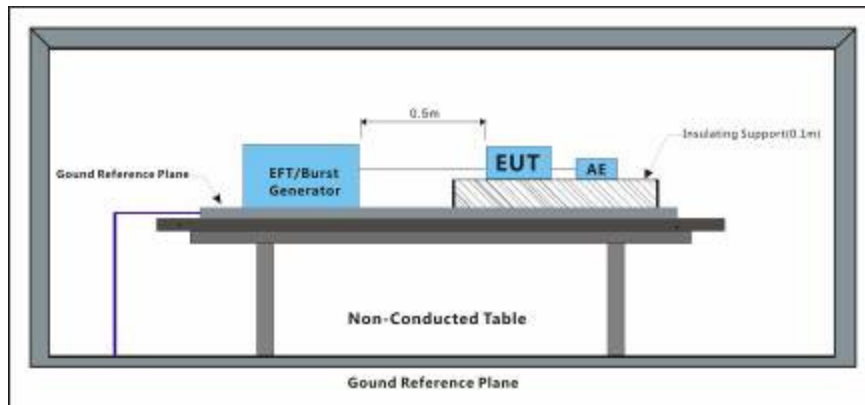

7.3.2 E.U.T. Operation

Operating Environment:

Temperature: 22 °C Humidity: 50 % RH Atmospheric Pressure: 1020 mbar

Test mode:
 a: Keep mode CDB092A running with AC220V,
 b: Keep mode CDB092E running with AC24V,
 c: Keep mode CDB092B running with DC24V,
 d: Keep mode CDB092F running with DC12V,
 e: Keep mode CDB092C running with AC110V.

7.3.3 Test Results:

Test Line	Level (kV)	Polarity	CDN/Clamp	Result / Observations
AC power port	1	+	CDN	A
AC power port	1	-	CDN	A

Results:

A: No degradation in the performance of the EUT was observed.

7.4 Surge at Power Port

Test Requirement: EN 61000-6-1:2007
 Test Method: EN 61000-4-5:2014 +A1:2017
 Performance Criterion: B
 Interval: 60s between each surge
 No. of surges: 5 positive, 5 negative at 0°, 90°, 180°, 270°.

7.4.1 Test Setup Diagram

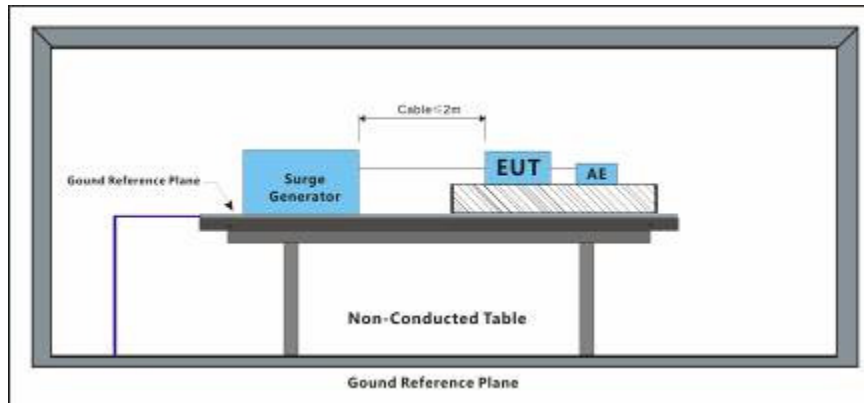

7.4.2 E.U.T. Operation

Operating Environment:
 Temperature: 22 °C Humidity: 50 % RH Atmospheric Pressure: 1020 mbar
 Test mode:
 a: Keep mode CDB092A running with AC220V,
 b: Keep mode CDB092E running with AC24V,
 c: Keep mode CDB092B running with DC24V,
 d: Keep mode CDB092F running with DC12V,
 e: Keep mode CDB092C running with AC110V.

7.4.3 Test Results:

Test Line	Level (kV)	Polarity	Phase (deg)	Result / Observations
L-N	1	+	0°	A
L-N	1	-	0°	A
L-N	1	+	90°	A
L-N	1	-	90°	A
L-N	1	+	180°	A
L-N	1	-	180°	A
L-N	1	+	270°	A
L-N	1	-	270°	A
L-PE	2	+	0°	A
L-PE	2	-	0°	A
L-PE	2	+	90°	A
L-PE	2	-	90°	A
L-PE	2	+	180°	A
L-PE	2	-	180°	A
L-PE	2	+	270°	A
L-PE	2	-	270°	A



N-PE	2	+	0°	A
N-PE	2	-	0°	A
N-PE	2	+	90°	A
N-PE	2	-	90°	A
N-PE	2	+	180°	A
N-PE	2	-	180°	A
N-PE	2	+	270°	A
N-PE	2	-	270°	A

Results:

A: No degradation in the performance of the EUT was observed.

7.5 Conducted Immunity at Power Port (150kHz-80MHz)

Test Requirement: EN 61000-6-1:2007
 Test Method: EN 61000-4-6:2014
 Performance Criterion: A
 Frequency Range: 0.15MHz to 80MHz
 Modulation: 80%, 1kHz Amplitude Modulation
 Step Size: 1%

7.5.1 Test Setup Diagram

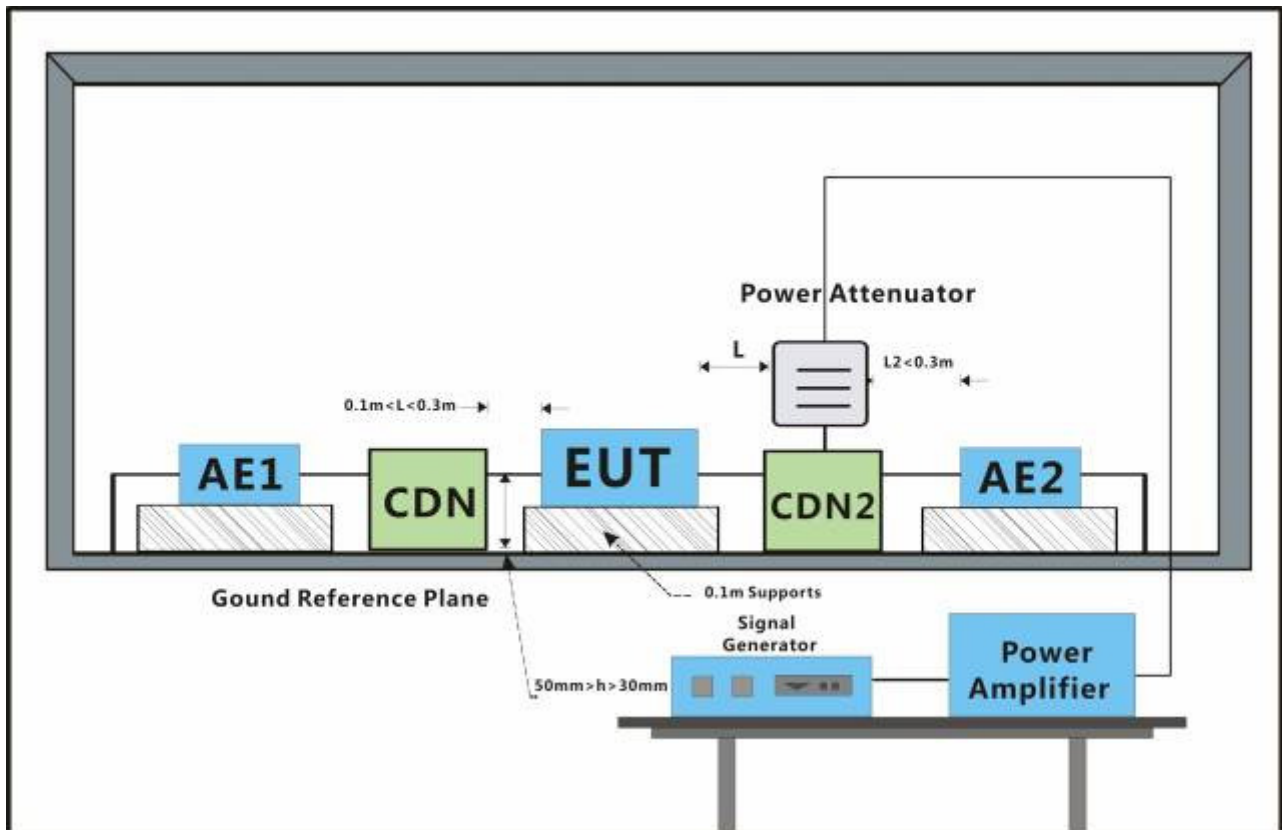

7.5.2 E.U.T. Operation

Operating Environment:

Temperature: 22 °C Humidity: 50 % RH Atmospheric Pressure: 1020 mbar

Test mode:
 a: Keep mode CDB092A running with AC220V,
 b: Keep mode CDB092E running with AC24V,
 c: Keep mode CDB092B running with DC24V,
 d: Keep mode CDB092F running with DC12V,
 e: Keep mode CDB092C running with AC110V.

7.5.3 Test Results:

Cable port	Level (Vrms)	CDN/Clamp	Dwell time	Result / Observations
AC power port	3	CDN	2s	A

Results:

A: No degradation in the performance of the EUT was observed.

7.6 Power Frequency Magnetic Field

Test Requirement: EN 61000-6-1:2007

Test Method: EN 61000-4-8:2010

Performance Criterion: A

7.6.1 Test Setup Diagram

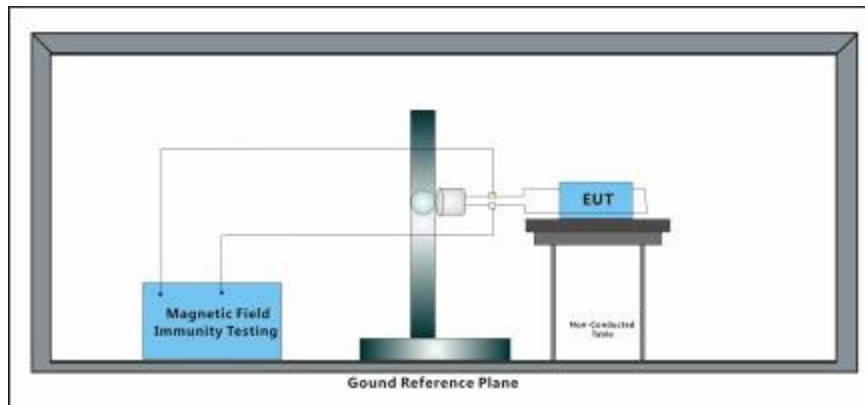

7.6.2 E.U.T. Operation

Operating Environment:

Temperature: 22 °C Humidity: 50 % RH Atmospheric Pressure: 1020 mbar

Test mode:
 a: Keep mode CDB092A running with AC220V,
 b: Keep mode CDB092E running with AC24V,
 c: Keep mode CDB092B running with DC24V,
 d: Keep mode CDB092F running with DC12V,
 e: Keep mode CDB092C running with AC110V.

7.6.3 Test Results:

Frequency	Level (A/m)	Axial	Magnetic Field Type	Result / Observations
50Hz	3	X	Continuous filed	A
50Hz	3	Y	Continuous filed	A
50Hz	3	Z	Continuous filed	A

Results:

A: No degradation in the performance of the EUT was observed.

7.7 Voltage Dips and Interruptions

Test Requirement: EN 61000-6-1:2007
 Test Method: EN 61000-4-11:2004 +A1:2017
 Performance Criterion: 0% of UT (Supply Voltage) for 0.5 Periods:B; 0% of UT for 1 Periods:B; 0% of UT for 250 Periods:C; 70% of UT for 25 Periods:C;
 No. of Dips / Interruptions: 3 per Level
 Time between dropout 10s

7.7.1 Test Setup Diagram

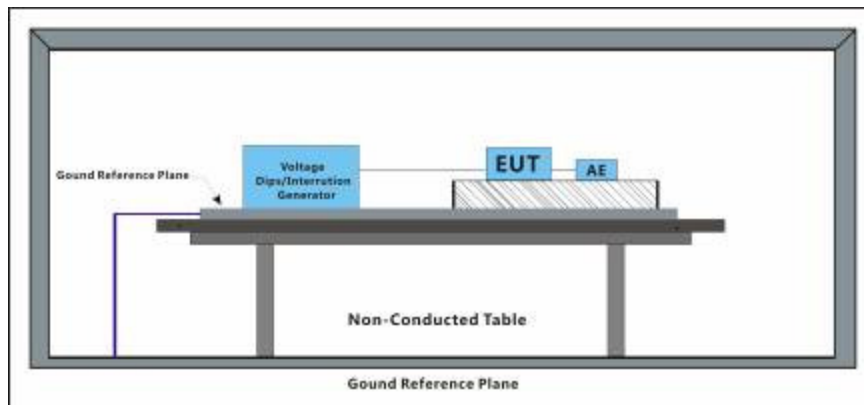

7.7.2 E.U.T. Operation

Operating Environment:
 Temperature: 22 °C Humidity: 50 % RH Atmospheric Pressure: 1020 mbar
 Test mode:
 a: Keep mode CDB092A running with AC220V,
 b: Keep mode CDB092E running with AC24V,
 c: Keep mode CDB092B running with DC24V,
 d: Keep mode CDB092F running with DC12V,
 e: Keep mode CDB092C running with AC110V.

7.7.3 Test Results:

Level % UT	Phase (deg)	Duration	No. of Dips / Interruptions	Result / Observations
0	0°	0.5 Cycles	3	A
0	180°	0.5 Cycles	3	A
0	0°	1 Cycles	3	A
0	180°	1 Cycles	3	A
70	0°	25 Cycles	3	A
70	180°	25 Cycles	3	A
0	0°	250 Cycles	3	A
0	180°	250 Cycles	3	A

Results:

A: No degradation in the performance of the EUT was observed.

7.8 Radiated Immunity(80MHz-2.7GHz)

Test Requirement: EN 61000-6-1:2007
 Test Method: EN 61000-4-3:2006 +A1:2008+A2:2010
 Performance Criterion: A
 Frequency Range: 80MHz to 1GHz, 1.4GHz to 2GHz, 2GHz to 2.7GHz
 Antenna Polarisation: Vertical and Horizontal
 Modulation: 1kHz,80% Amp. Mod,1% increment

7.8.1 Test Setup Diagram

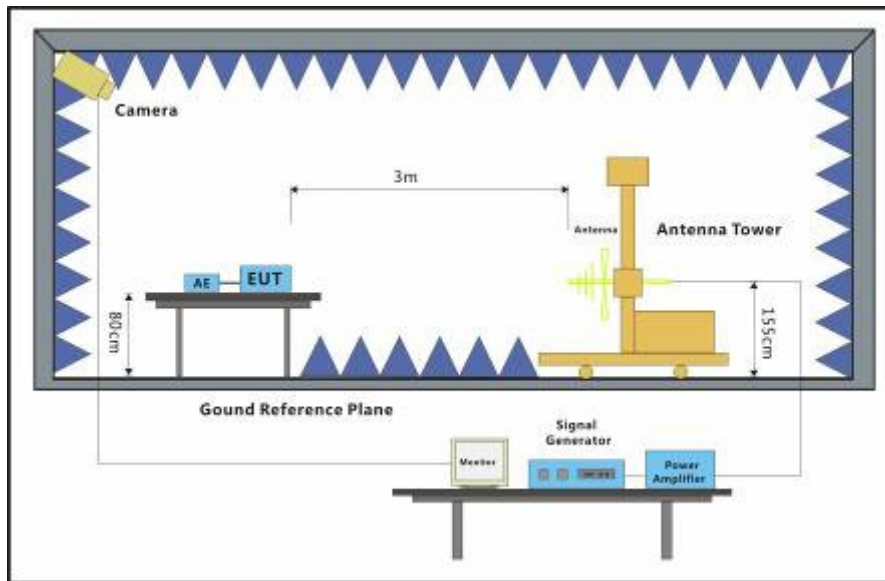

7.8.2 E.U.T. Operation

Operating Environment:

Temperature: 22 °C Humidity: 50 % RH Atmospheric Pressure: 1020 mbar

Test mode:
 a: Keep mode CDB092A running with AC220V,
 b: Keep mode CDB092E running with AC24V,
 c: Keep mode CDB092B running with DC24V,
 d: Keep mode CDB092F running with DC12V,
 e: Keep mode CDB092C running with AC110V.

7.8.3 Test Results:

Frequency	Level (V/m)	EUT Face	Dwell time	Result / Observations
80MHz-1GHz	3	Front	2s	A
80MHz-1GHz	3	Back	2s	A
80MHz-1GHz	3	Left	2s	A
80MHz-1GHz	3	Right	2s	A
80MHz-1GHz	3	Top	2s	A
80MHz-1GHz	3	Underside	2s	A
1.4GHz-2GHz	3	Front	2s	A
1.4GHz-2GHz	3	Back	2s	A
1.4GHz-2GHz	3	Left	2s	A
1.4GHz-2GHz	3	Right	2s	A
1.4GHz-2GHz	3	Top	2s	A



1.4GHz-2GHz	3	Underside	2s	A
2GHz-2.7GHz	1	Front	2s	A
2GHz-2.7GHz	1	Back	2s	A
2GHz-2.7GHz	1	Left	2s	A
2GHz-2.7GHz	1	Right	2s	A
2GHz-2.7GHz	1	Top	2s	A
2GHz-2.7GHz	1	Underside	2s	A

Results:

A: No degradation in the performance of the EUT was observed.

8 Photographs

8.1 Conducted Emissions at Mains Terminals (150kHz-30MHz) Test Setup

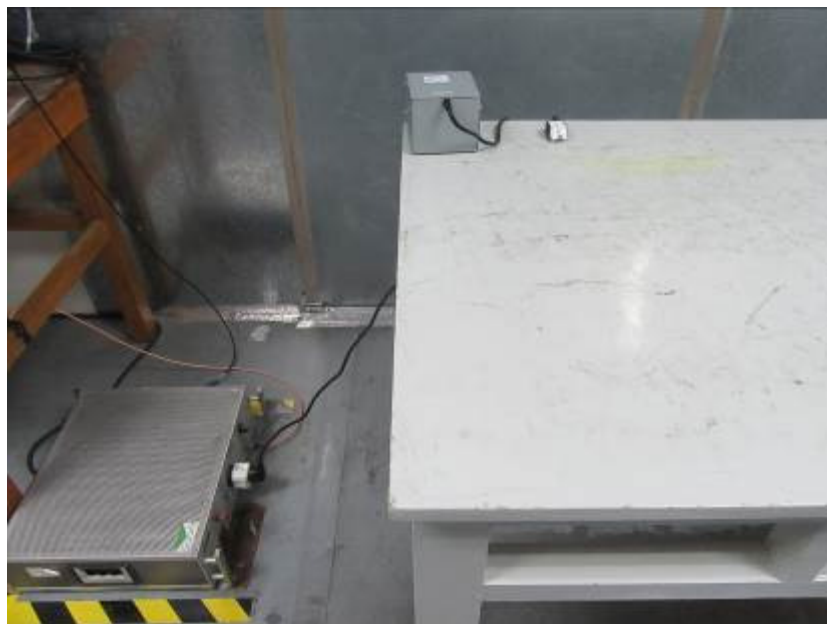

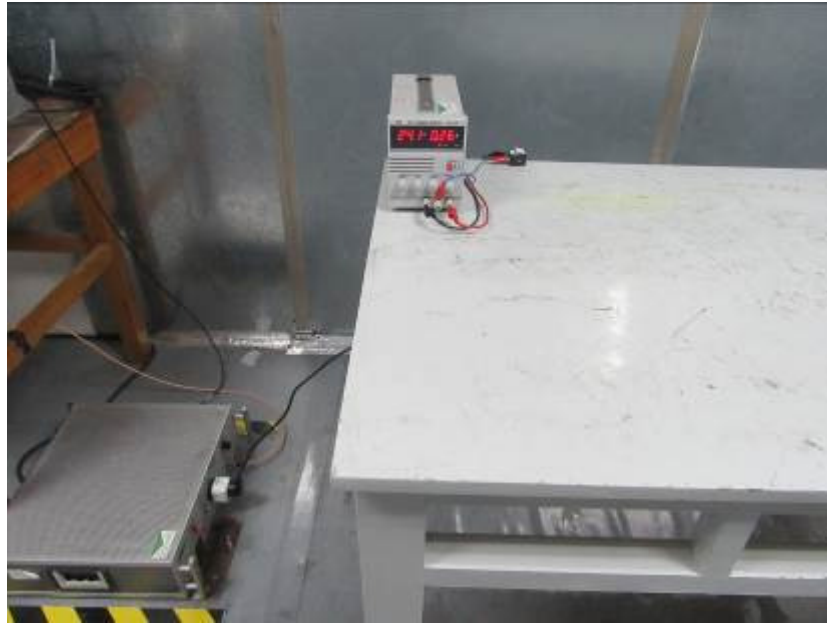

8.2 Radiated Emissions (30MHz-1GHz) Test Setup







8.3 Voltage Fluctuations and Flicker Test Setup



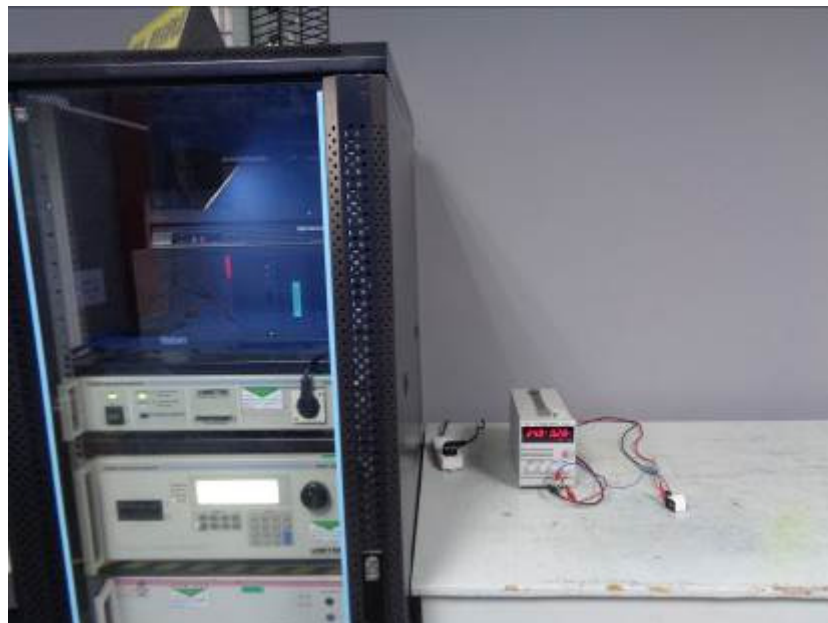

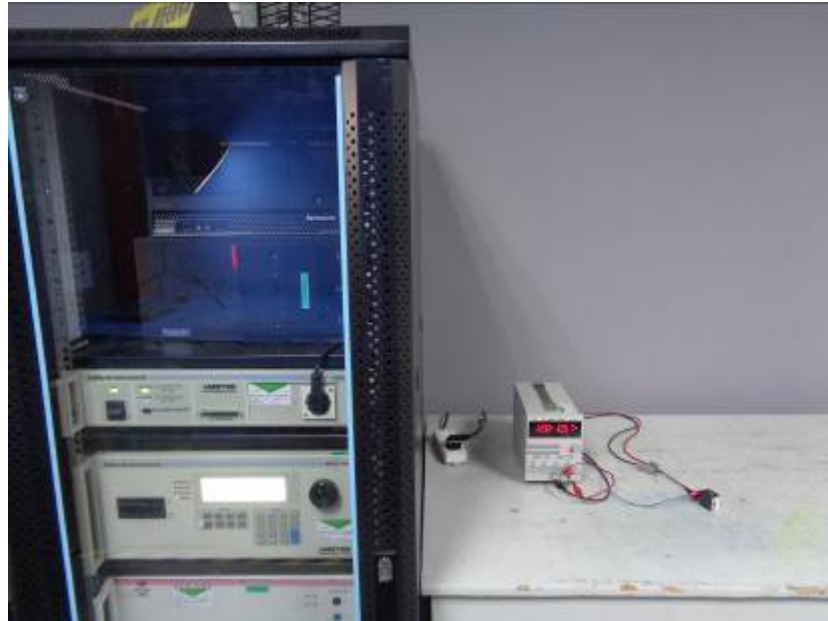

8.4 Electrostatic Discharge Test Setup







8.5 Electrical Fast Transients/Burst at Power Port Test Setup

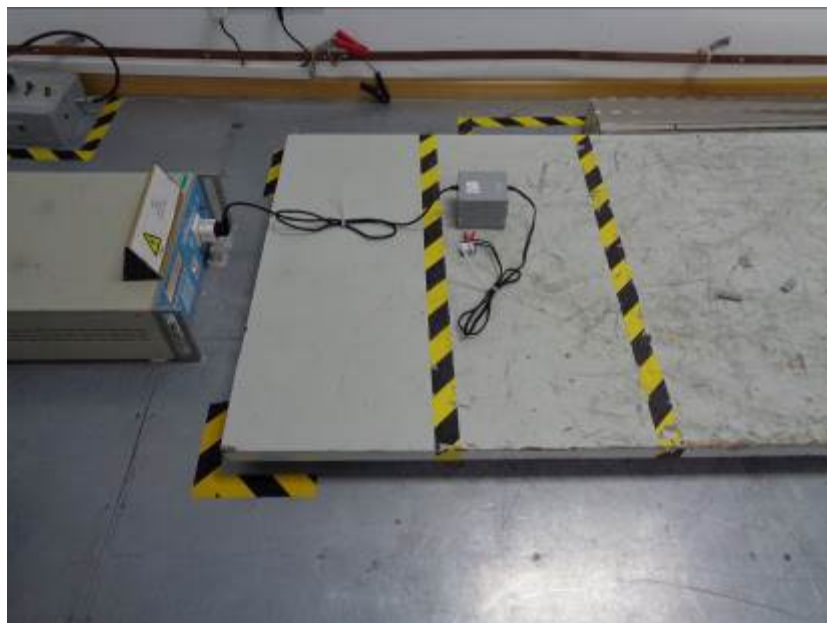



8.6 Surge at Power Port Test Setup





8.7 Conducted Immunity at Power Port (150kHz-80MHz) Test Setup

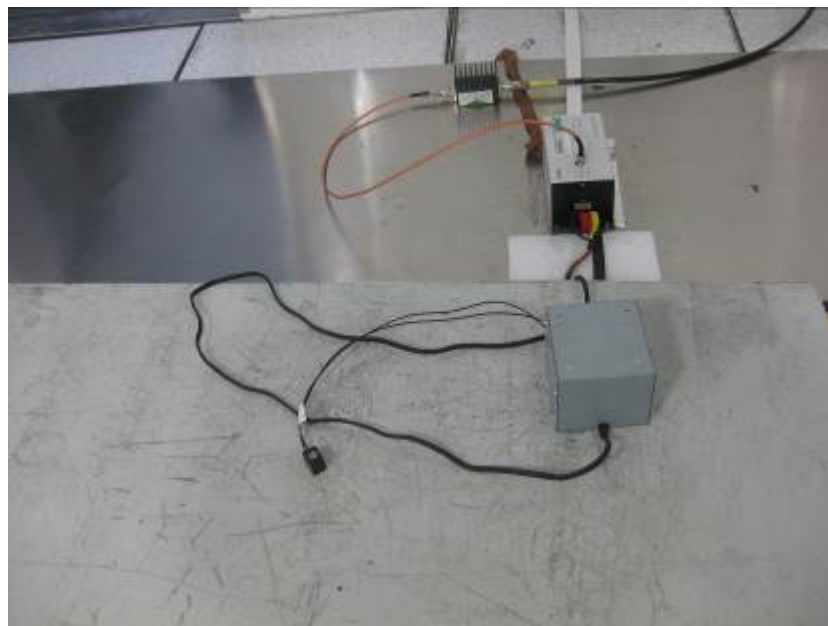
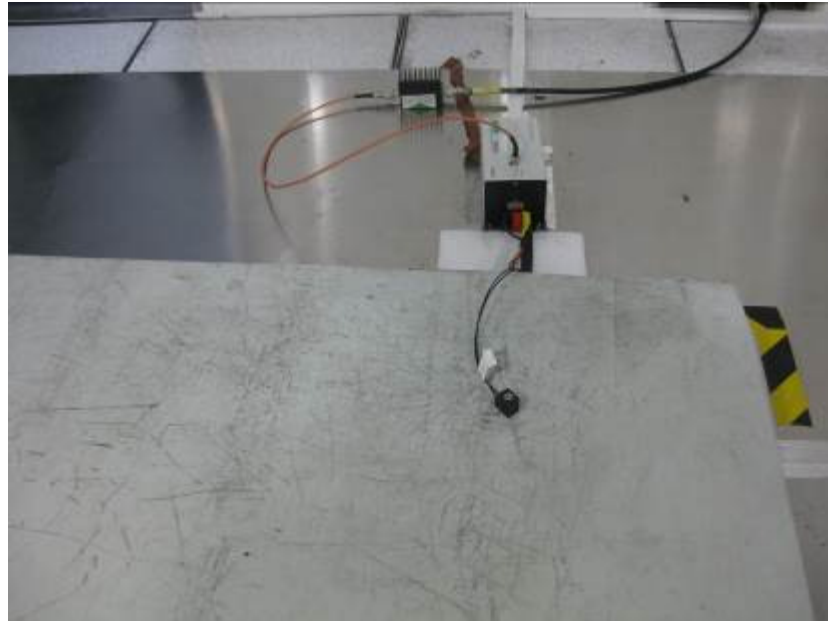

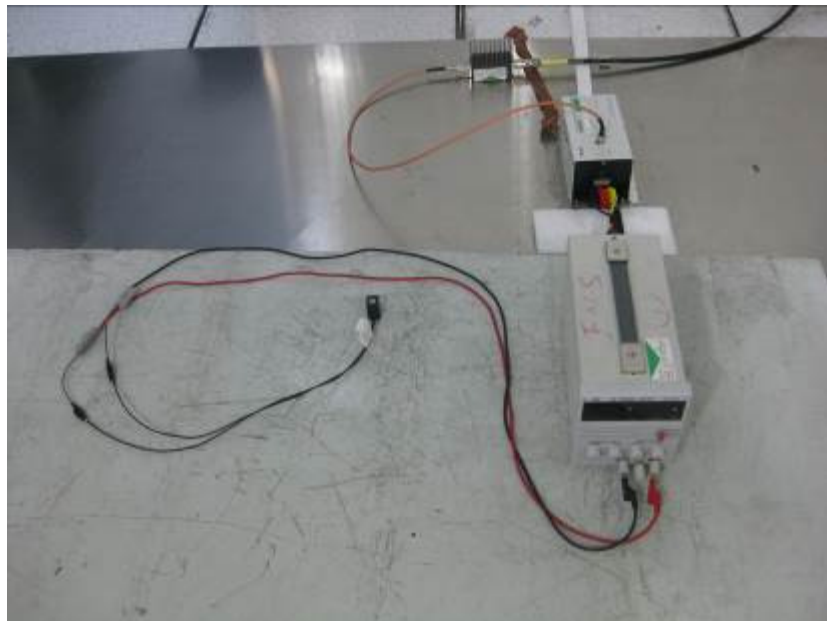
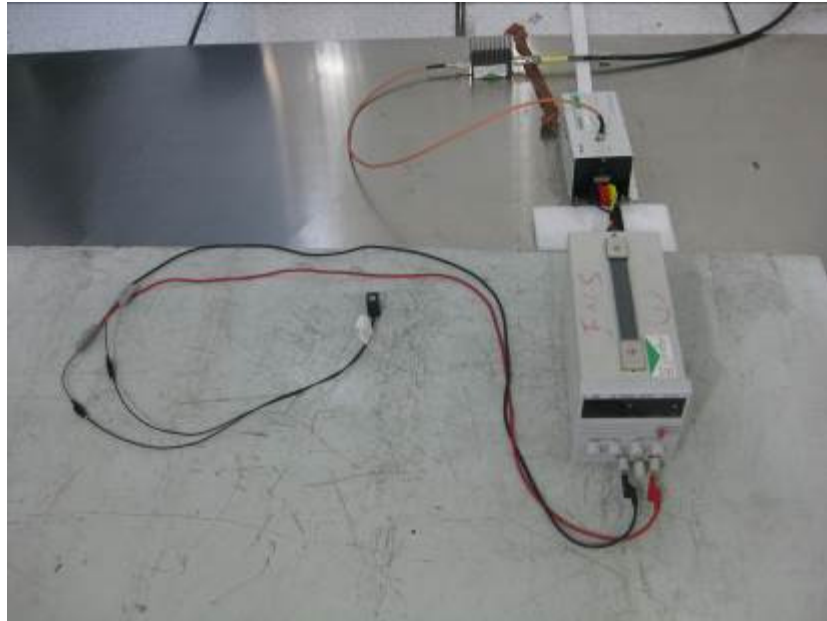

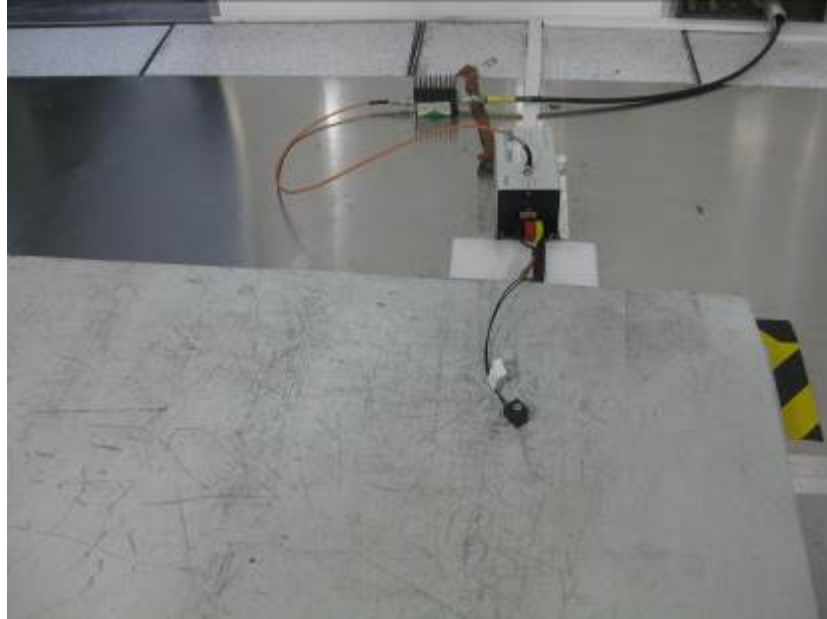

8.8 Power Frequency Magnetic Field Test Setup

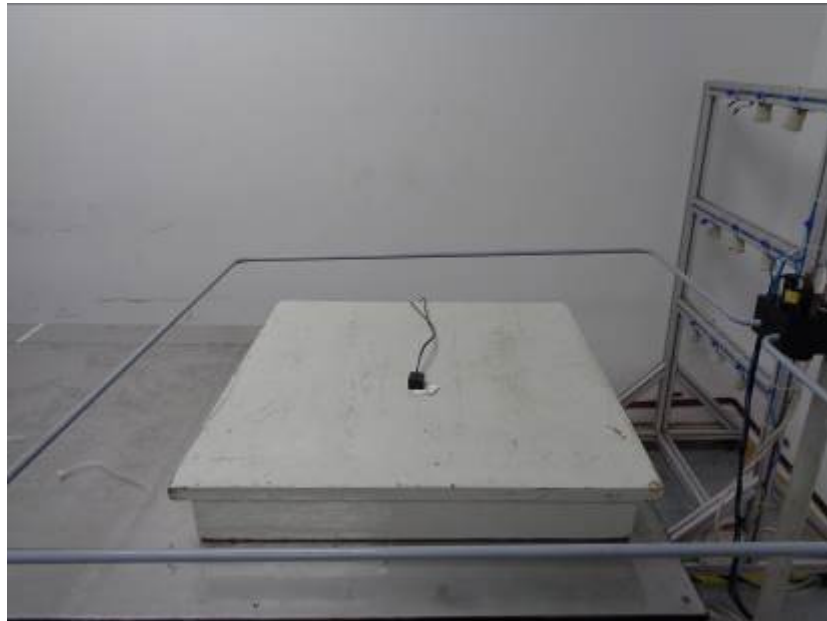

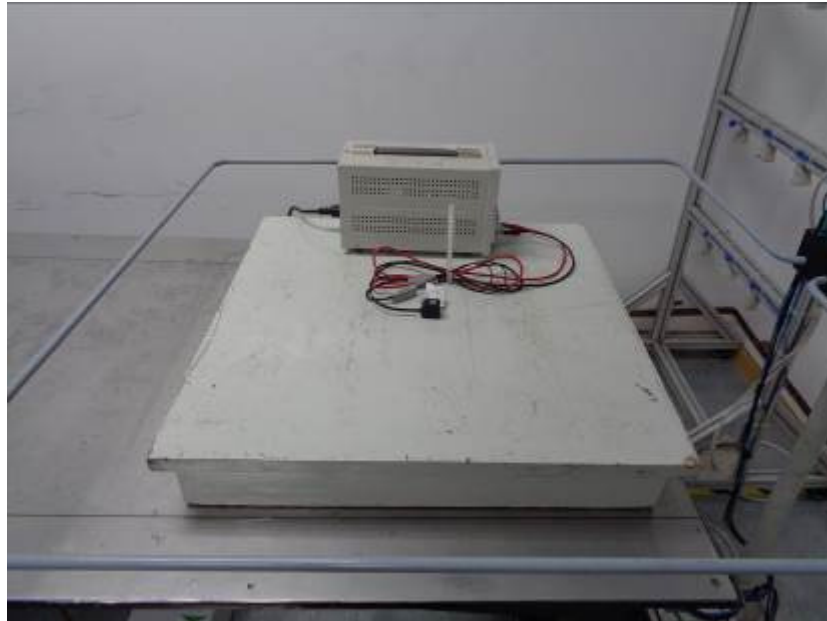

8.9 Voltage Dips and Interruptions Test Setup





8.10 Radiated Immunity(80MHz-2.7GHz) Test Setup







8.11 EUT Constructional Details (EUT Photos)

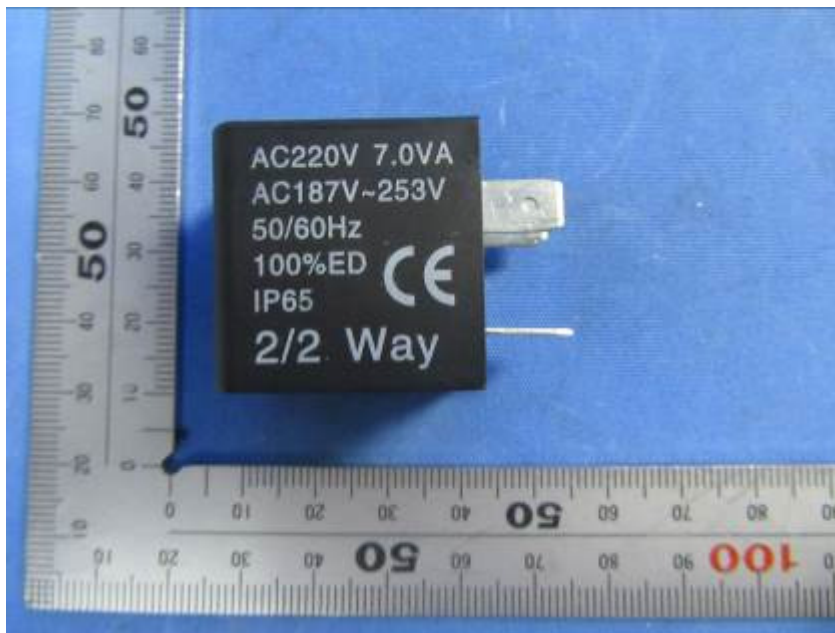

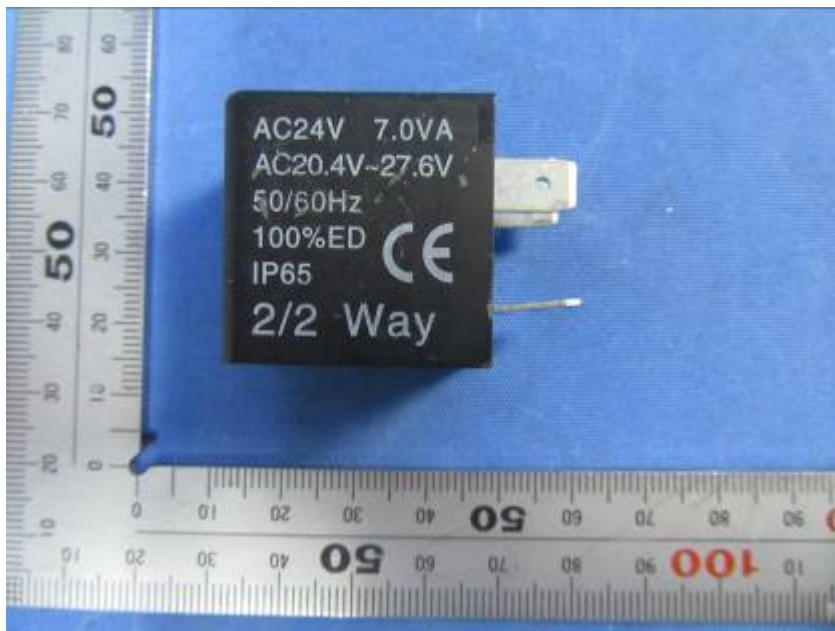

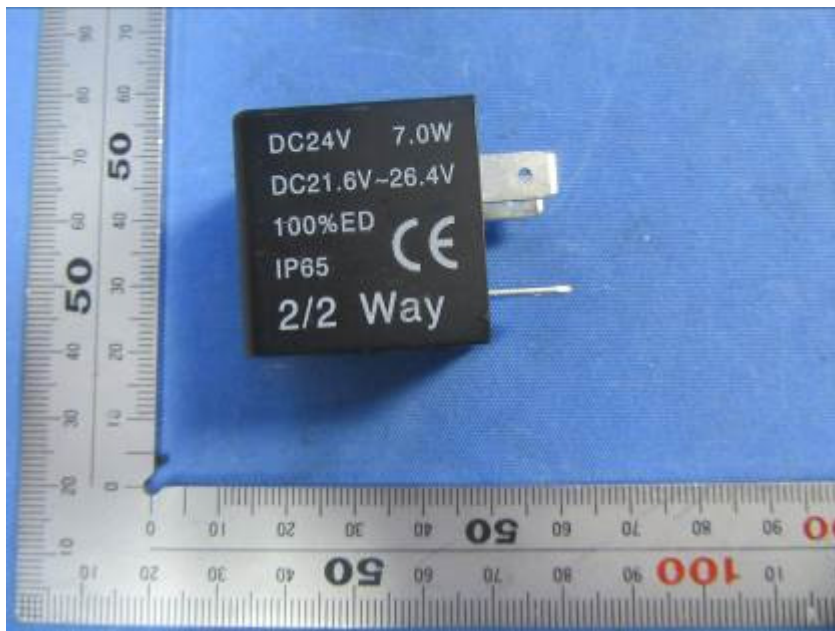





- End of the Report -